Bassline

Statement of Line	258
--------------------------	------------

Product Details

Occasional Tables	260
Base-Only Table	262
Three Leg Tables	264
Box Top Tables	268
Bench Seating	270
Power	272

Specifying

Square and Rectangular Tables	274
Round Tables	276
Oval Tables	278
Racetrack Tables	280
Three Leg Tables	282
Box Top Tables	284
One Seat Bench	290
Two Seat Bench	292
Base-Only Tables	294
Power	296

Surface Materials	298
--------------------------	------------

Statement of Line

Occasional Tables

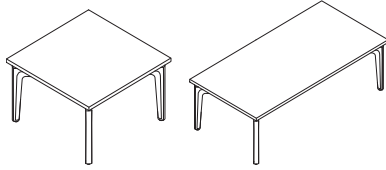

Understanding
 ▶ Page 260
 Specifying
 ▶ Page 274

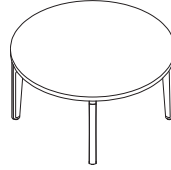

Understanding
 ▶ Page 260
 Specifying
 ▶ Page 276

Square and Rectangular Tables

	18 ⁷ / ₈ "W	28 ³ / ₄ "W	36"W	54"W	60"W
18 ⁷ / ₈ "D	●				
20"D			●		
24"D				●	
28 ³ / ₄ "D	●				●

Round Tables

25" Diameter	●
39" Diameter	●

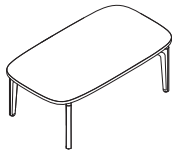

Understanding
 ▶ Page 260
 Specifying
 ▶ Page 278

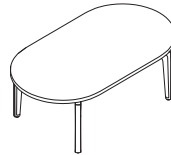

Understanding
 ▶ Page 260
 Specifying
 ▶ Page 280

Oval Tables

	36"W	54"W	60"W
20"D	●		
24"D		●	
28 ³ / ₄ "D			●

Racetrack Tables

	36"W	54"W	60"W
20"D	●		
24"D		●	
28 ³ / ₄ "D			●

Three Leg Tables



Small Three Leg Table
 Understanding
 ▶ Page 264
 Specifying
 ▶ Page 282



Medium Three Leg Table
 Understanding
 ▶ Page 264
 Specifying
 ▶ Page 282

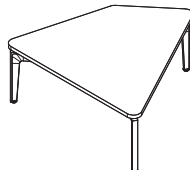

Large Three Leg Table
 Understanding
 ▶ Page 264
 Specifying
 ▶ Page 282

Box Top Tables



Box Top Table
 Understanding
 ▶ Page 268
 Specifying
 ▶ Page 284

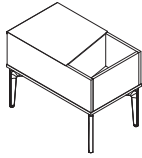

Box Top Table with Bag Drop
 Understanding
 ▶ Page 268
 Specifying
 ▶ Page 284

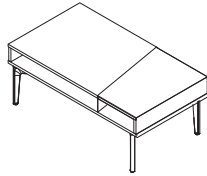

Box Top Coffee Table
 Understanding
 ▶ Page 268
 Specifying
 ▶ Page 288

Bench Seating



One Seat Bench
 Understanding
 ▶ Page 270
 Specifying
 ▶ Page 290

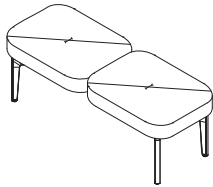

Two Seat Bench
 Understanding
 ▶ Page 270
 Specifying
 ▶ Page 292

Power

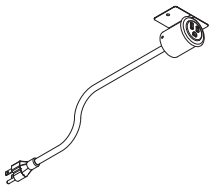

Round Power
 Understanding
 ▶ Page 272
 Specifying
 ▶ Page 296

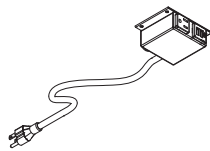

Module Power
 Understanding
 ▶ Page 272
 Specifying
 ▶ Page 296

Occasional Tables

Occasional tables are available in round, square, rectangular, oval, and racetrack.

Tables tops are offered in Low-Pressure Laminate, High-Pressure Laminate, veneer, glass, and Corian.

Overall table height is 13" including the legs, spacer, and table top.
 ▶ Specifying, pages 274–280

Tables tops are 3/4" thick.

Leveling glides have 1/2" adjustability range to install tables on uneven floors.

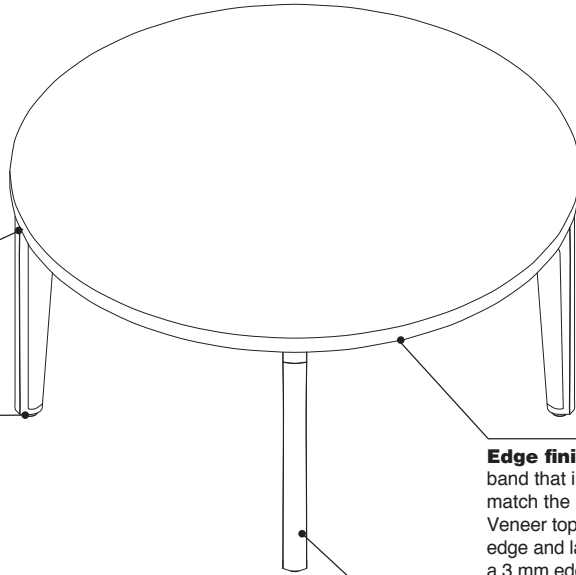

Edge finish has an edge band that is defaulted to match the laminate surface. Veneer tops have a wood edge and laminate tops have a 3 mm edge.

Leg height is 12 1/4".

Product Details

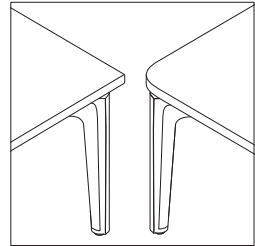

Square and rectangular tables have options for rounded corners or squared corners.

Occasional tables and Bivi Rumble Seat legs share the same visual aesthetic.
 ▶ See page 44 for Bivi Rumble Seat information.

Surface Materials

- Table tops**
- Low-Pressure Laminate
 - High-Pressure Laminate
 - Open Line laminate
 - Wood veneer
 - Glass*
 - Corian*

*Note: Only available with round corners.

- Legs**
- Paint

Actual Dimensions

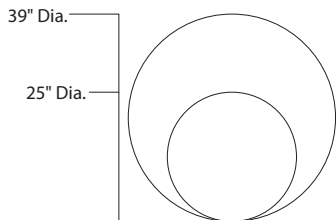
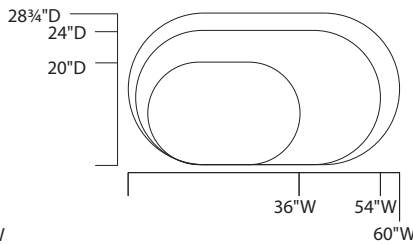
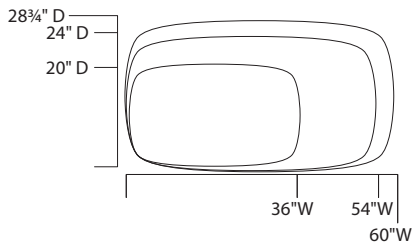
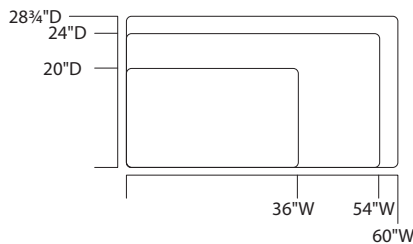
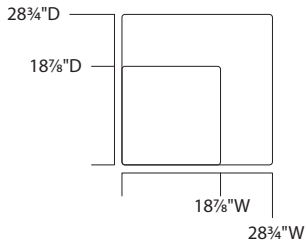

Base-Only Tables

Base-Only Tables enable you to personalize your table with a custom top and make it your own.

► Specifying page, 294

The Base-Only Tables come with a black 3/4" Low-Pressure Laminate (LPL) platform in the shape specified. Adhere custom top to the platform using the provided 3M™ hook and loop fasteners.

Tip: Base-Only Tables platform is smaller than the legs. Custom top will extend beyond the platform to align with the legs.

Fully assembled tables support a maximum weight of 800 pounds. This includes the weight of your custom top and any items put on the table.

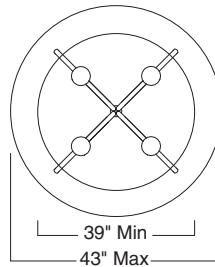
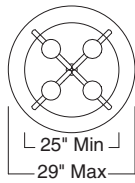
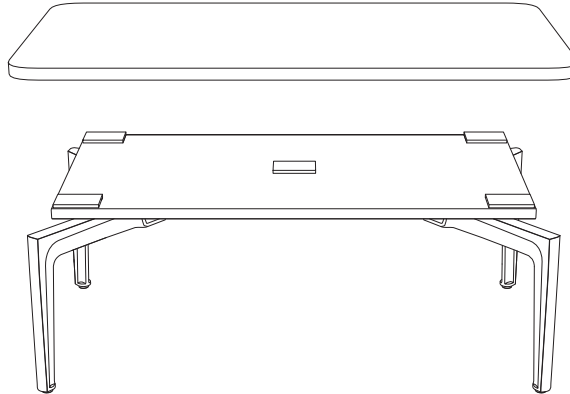

Your custom top for circle bases may not extend more than 2" in any direction from the standard Base-Only Table size.

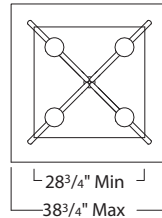
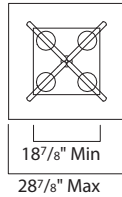

Your custom top for square bases may not extend more than 5" in any direction from the standard Base-Only Table size.

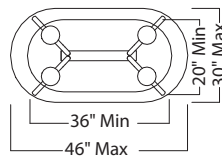
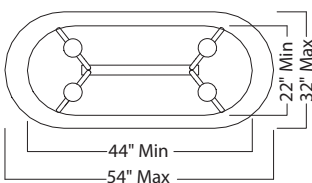
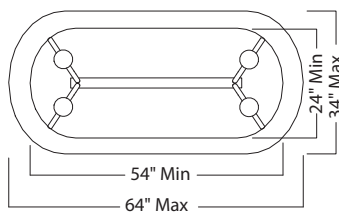
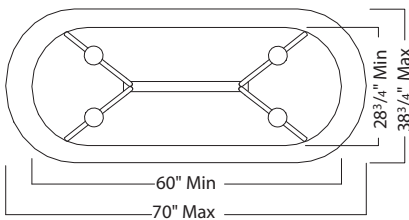
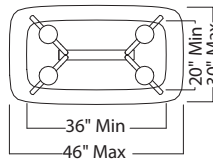
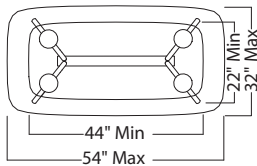
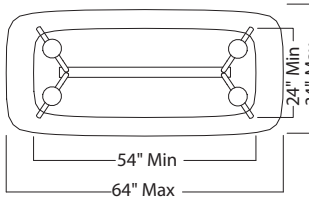
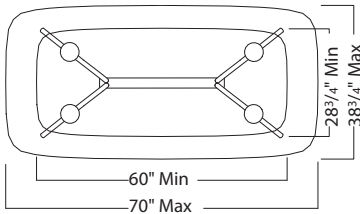
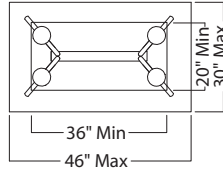
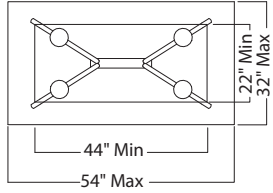
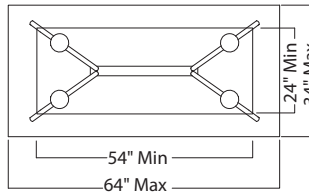
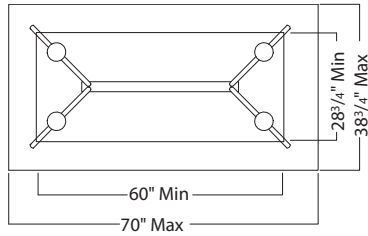

Your custom top for rectangular, oval, and racetrack bases may not extend more than 5" in any direction from the standard Base-Only Table size.

Three Leg Tables

Three Leg Tables have an irregular shape and are offered in Low-Pressure Laminate, High-Pressure Laminate, veneer, glass, and Corian.

Overall table height is 13" including the legs, spacer, and table top.
▶ Specifying, page 282

Table tops are $\frac{3}{4}$ " thick.

Leveling glides have $\frac{1}{2}$ " adjustability range to install tables on uneven floors.

Edge finish has an edge band that is defaulted to match the laminate surface. Veneer tops have a wood edge and laminate tops have a 3 mm edge.

Leg height is 12 $\frac{1}{4}$ ".

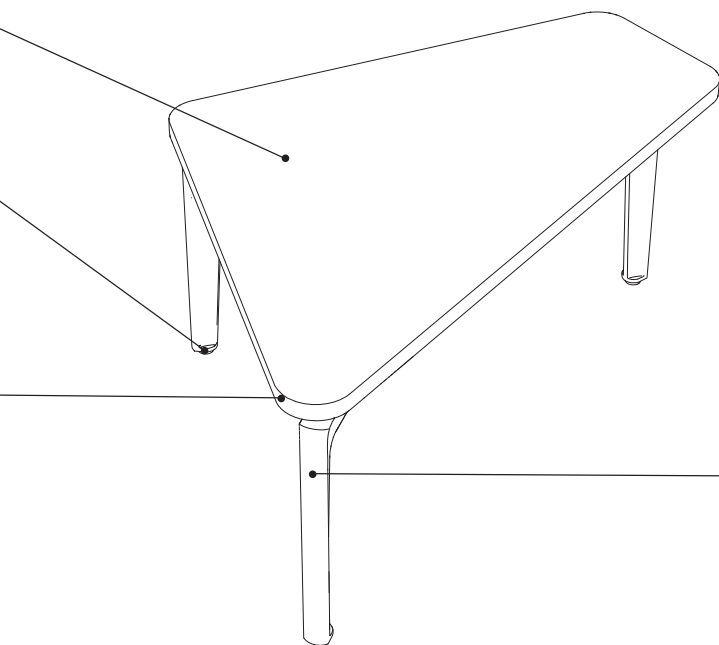

Three Leg Tables are available in small, medium, and large.

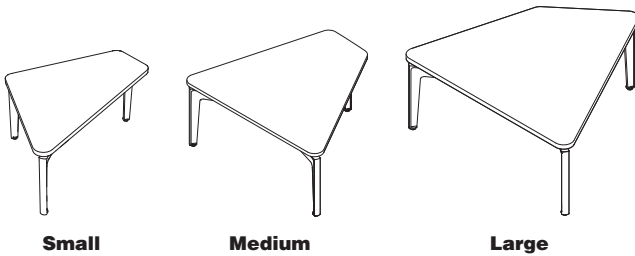

Product Details

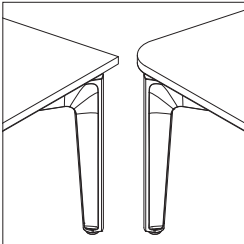

Three Leg Tables and Bivi Rumble Seat legs share the same visual aesthetic.
 ▶ See page 44 for Bivi Rumble Seat information.



Grain direction for Small Three Leg Table.

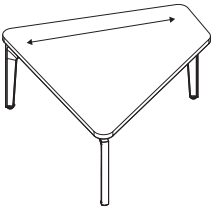

Grain direction for Medium Three Leg Table.

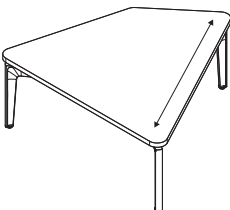

Grain direction for Large Three Leg Table.

Application Topics

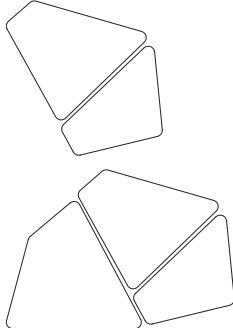

Three Leg Tables can be used separately or grouped together.

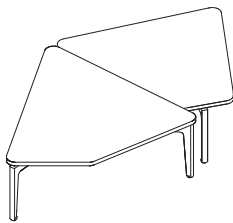

Large Three Leg Table with Medium Three Leg Table shown above.

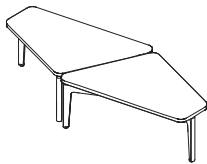

Small Three Leg Table with Large Three Leg Table shown above.

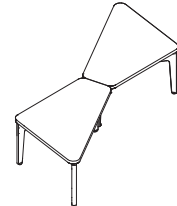

Small Three Leg Table with Small Three Leg Table shown above.

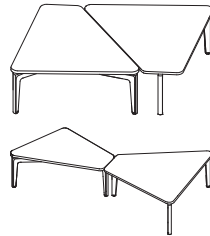

Small Three Leg Table with Medium Three Leg Table shown above.

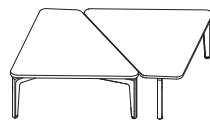
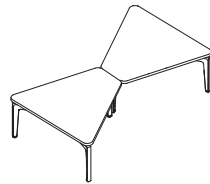

Medium Three Leg Table with Medium Three Leg Table shown above.



Small Three Leg Table with Large Three Leg Table shown above.

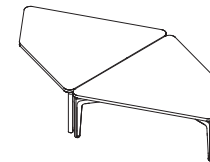

Large Three Leg Table with Large Three Leg Table shown above.

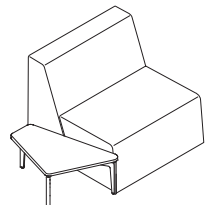

Small Three Leg Table with Campfire Lounge shown above.

Surface Materials

Table tops

- Low-Pressure Laminate
- High-Pressure Laminate
- Open Line laminate
- Wood veneer
- Glass
- Corian

Base

- Paint

Dimensions

▶ Page 266

Dimensions

Three Leg Tables

• Features • Overall
 Depth Width Height

Three Leg Tables

Small

26³/₄" 22¹/₈" 13"

Medium

34" 26²/₅" 13"

Large

35" 29³/₄" 13"

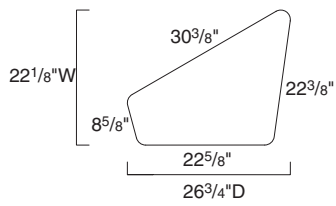

Small Three Leg Table

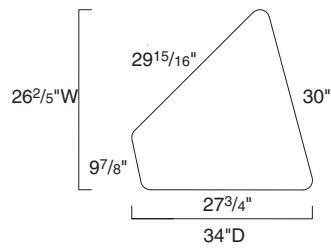

Medium Three Leg Table

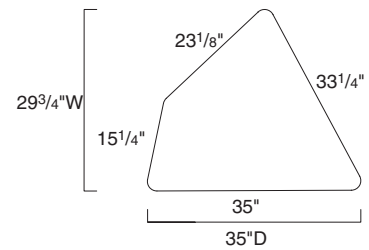

Large Three Leg Table

Box Top Tables

Box Top Tables are offered in Low-Pressure Laminate, High-Pressure Laminate, and veneer with painted metal accents; location varies by table. The metal accent panel is available with or without a design.
 ▶ Specifying pages, 284-289

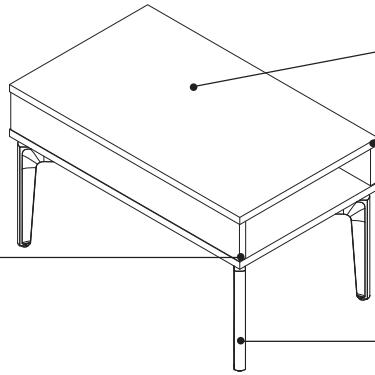

The 25"D and 30"D Box Top Tables have a metal accent panel inside the case. It is available with or without a design.

Edge finish has an edge band that is defaulted to match the laminate surface. Veneer tops have a wood edge and laminate tops have a 3 mm edge.

Leg height is 12¹/₄".

Top and sides of Box Top Tables are 3/4" thick.

Box Top Tables with Bag Drop feature a metal accent panel top and a top accessible space for convenient storage of bags, books, or personal items (shown without optional design).

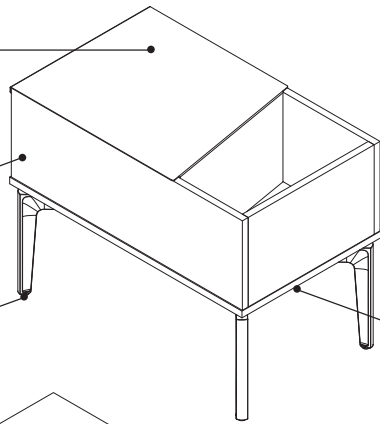

Box Top Tables with Bag Drop are available in two depths.

All Bassline tables have leveling glides with 1/2" adjustability range to install tables on uneven floors.

Box Top Tables and Box Top Tables with Bag Drop have pre-drilled pilot holes to accommodate power.

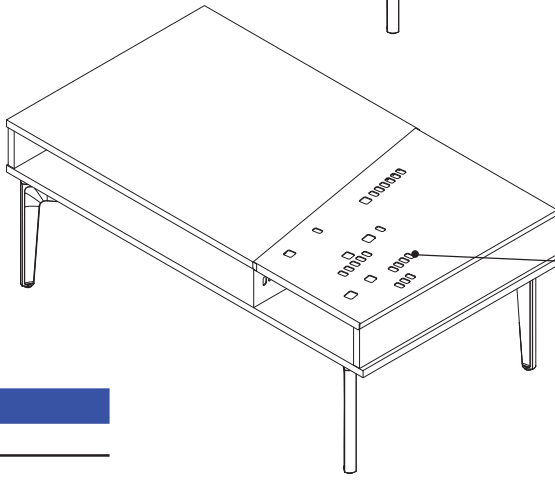

Box Top Coffee Table features a metal accent panel on the top and inside for visual interest (shown with optional design).

Actual Dimensions

Box Top Tables

Depth 25" or 30"
 Width 18"
 Height 18" or 23"

Box Top Tables with Bag Drop

Depth 25" or 30"
 Width 18"
 Height 23"

Box Top Coffee Table

Depth 25"
 Width 54"
 Height 18"

Product Details

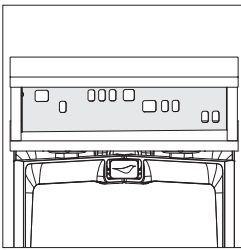
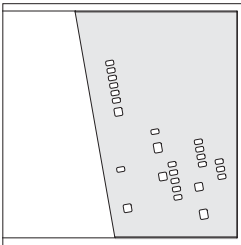

Box Top Tables have a standard metal accent panel that can be specified with or without a cut out design. Design shown on Box Top Table with Bag Drop (top) and a Box Top Table (bottom).

If the cut out design is specified, it will be applied to the metal accent panel.

Paint for metal accent panel and base are specified separately allowing match or mix finishes.

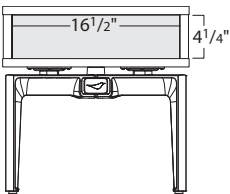

18"H Box Top Table opening

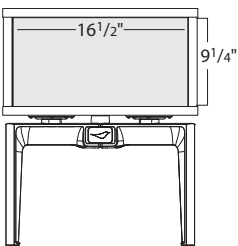

23"H Box Top Table and Box Top Table with Bag Drop opening

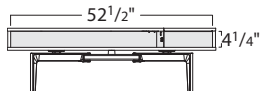

Box Top Coffee Table opening

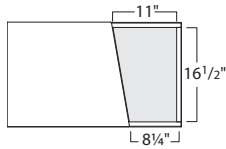

25"D and 30"D Bag Drop opening

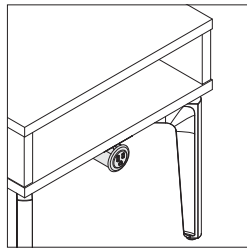

Round and module power available for Box Top Tables.

▶ See page 296

Box Top Tables and Bivi Rumble Seat legs

share the same visual aesthetic.

▶ See page 44 for Bivi Rumble Seat information.

Application Topics

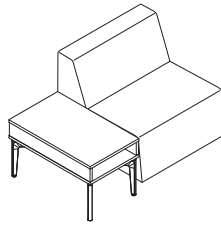

30"D Box Top Tables align with Campfire Lounge.

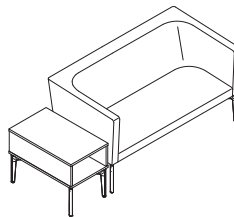

25"D Box Top Tables align with the Freestanding Bivi Rumble Seat.

Surface Materials

Table tops

- Low-Pressure Laminate
- High-Pressure Laminate
- Open Line laminate
- Wood veneer

Base

- Paint

Metal accent panel

- Paint

Bench Seating

Built on the same base as Bassline tables, Benches act as seating, ottomans, or side tables. They are available in One Seat or Two Seat configurations.

Overall height is 17¹/₄" including the legs and seat.
 ▶ Specifying pages, 292-293

Side table corners are rounded.

Side table has a table top thickness of ³/₄" and is available as an option on the One Seat Bench.

Diagonal stitching is in the center of the seat.

Contrasting stitching is optional.

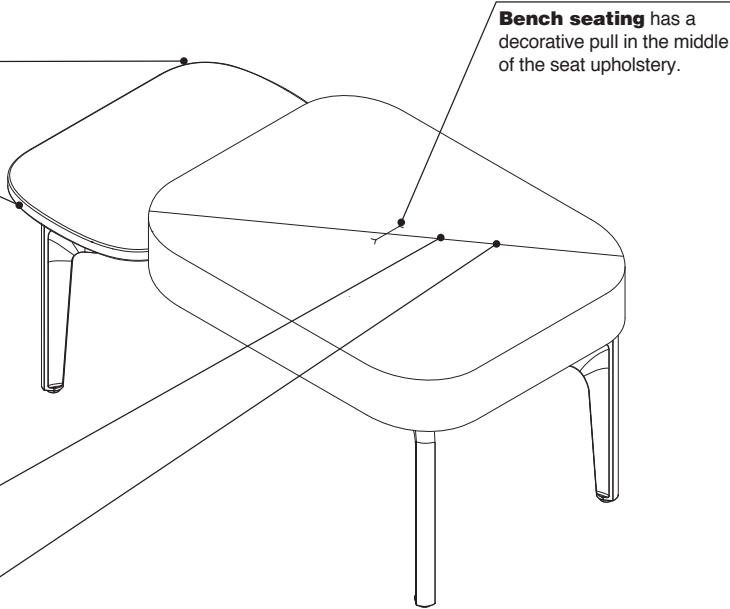

Bench seating has a decorative pull in the middle of the seat upholstery.

Actual Dimensions

One Seat Bench	
Depth	18"
Width	24"
Height	17 ¹ / ₄ "

One Seat Bench with Side Table	
Depth	18"
Width	36"
Height	17 ¹ / ₄ "

Two Seat Bench	
Depth	18"
Width	48"
Height	17 ¹ / ₄ "

Product Details



Solid Seat



Multicolor Seat

One Seat Bench and One Seat Bench with Table are available with a solid color seat or multicolor seat.

Tip: Multicolor seat must be in the same fabric family.



Solid Non-Contrasting Seat



Solid Contrasting Seat



One Solid Seat, One Multicolor Seat



Multicolor, Non-Contrasting Seats



Multicolor, Contrasting Seats

Two Seat Bench available as solid non-contrasting, solid contrasting, multicolor non-contrasting, multicolor contrasting, and one solid and one contrasting.

Tip: Multicolor seats must be from the same color family.

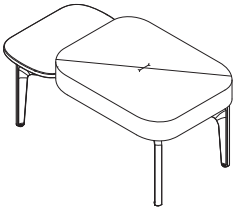

Side table is available as an option on One Seat Bench. Side table is assembled on the right.

When ordering multi-color upholstery on a One Seat Bench with a side table, keep in mind where your color choices will be in regards to the seat front/seat back.

Surface Materials

- Seat**
- Fabric

Contrasting Thread

- UB01 Charcoal
- UB02 Ash
- UB03 Powder Blue
- UB04 Evergreen
- UB05 Bright Red

Base

- Paint

Side table (optional)

- Low-Pressure Laminate
- High-Pressure Laminate
- Open Line laminate
- Wood

Power

Round and Module power facilitate function and accessibility by bringing the power to the user.

Round power available in plastic colors to coordinate or accent in a space.

Module power available in black plastic only.
▶ Specifying, page 296

Steelcase products are designed and tested for code and standard compliance when installed and used as an integrated product solution in accordance with Steelcase application guidelines and installation instructions. However, the building owner or designated agent is responsible for verifying that the installation is in compliance with local codes and regulations.

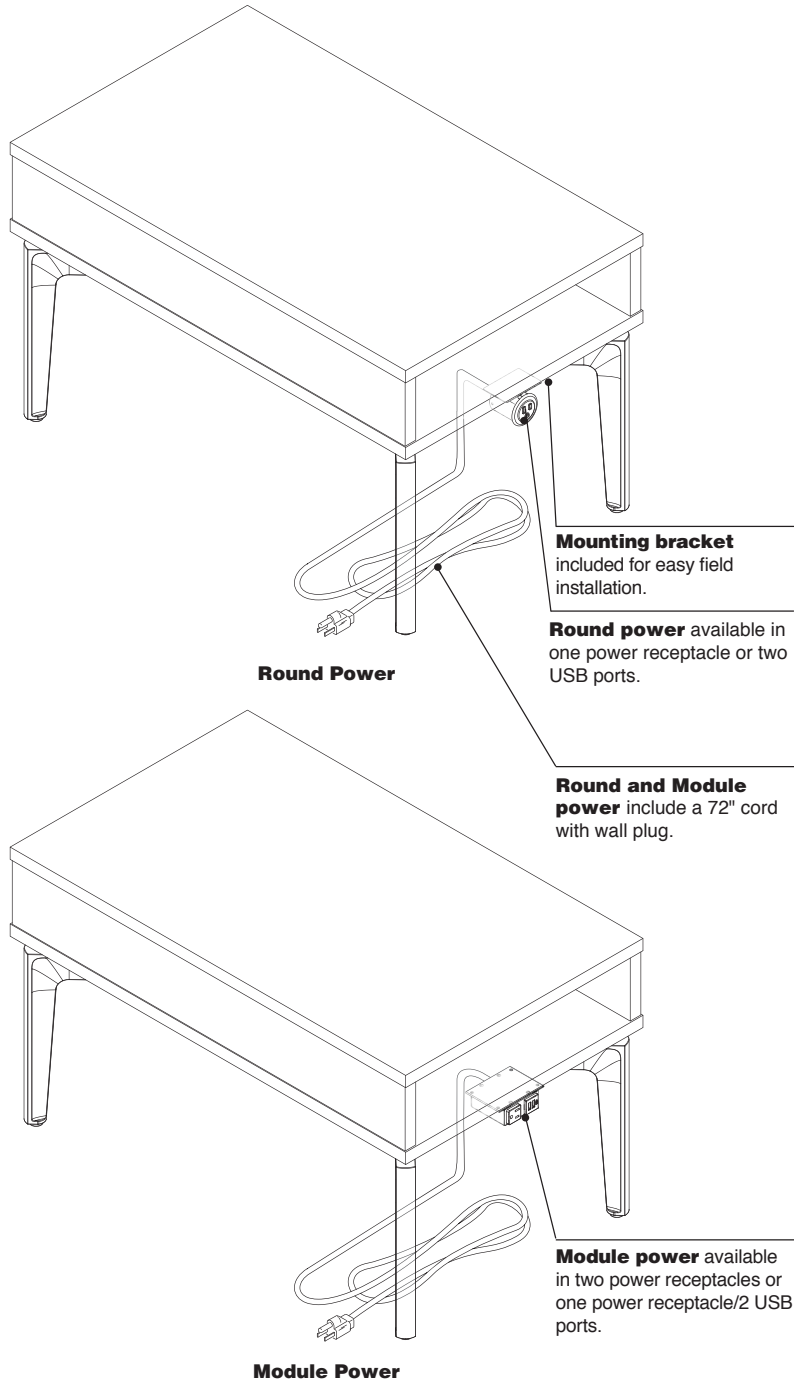

Product Details

Round or Module power have been tested and approved for use with the Box Top Table, TSBLNTBX, and Box Top Table with Bag Drop, TSBLNTBxB.

Box Top Tables and Box Top Tables with Bag Drop have pre-drilled pilot holes to accommodate power.



Round power is available with one power receptacle or 2 USB ports.

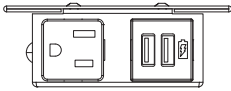
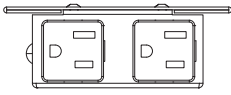

Module power is available with two power receptacles or one power receptacle/2 USB ports.

Round and Module power include a 72" cord with wall plug.

Wiring and Cabling

Round power features one simplex 15-amp spill proof receptacle.

Module power features two simplex 15-amp receptacles.

Round power has optional dual USB ports and offers 2-amps per port. Module power has optional dual USB ports in place of one receptacle.

All electrical components are cULus listed to the appropriate industry standards in accordance with the National and Canadian Electrical code.

Surface Materials

Round Power

- 5U23 Blue Jay
- 6249 Platinum Solid
- 6337 Element
- 6338 Chili
- 6527 Merle

Module Power

- 6000 Black

Bracket

- 7360 Merle

Square and Rectangular Tables

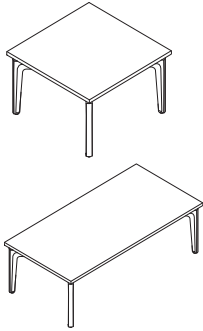

Tip: Overall table height is 13" including the legs and table top.

Tip: Wood veneer tables have matching flat veneer profile edges.

Standard Includes	Required to Specify
-------------------	---------------------

- | | | |
|--|--|--|
| <ul style="list-style-type: none"> ▶ Need help? Product details, page 260 | <ul style="list-style-type: none"> • 3/4"-thick table top: Low-Pressure Laminate • 3 mm edge band: default color to match laminate • Base: paint price group 1 • Glides • Ships ready to assemble | <ol style="list-style-type: none"> 1 Style number 2 Size (see below under Required Selections) 3 Corner type (see below under Required Selections) 4 Laminate color number for table top 5 Paint color number for base 6 Options, if selected (see below) <p>▶ See <i>Surface Materials</i>, page 298.</p> |
|--|--|--|

	Required Selections	U.S Price	Required to Specify
Size	<ul style="list-style-type: none"> • 18⁷/₈"D x 18⁷/₈"W • 20"D x 36"W • 28³/₄"D x 28³/₄"W • 24"D x 54"W • 28³/₄"D x 60"W 	<p>Prices at right</p> <p>Prices at right</p> <p>Prices at right</p> <p>Prices at right</p> <p>Prices at right</p>	<p>Specify size.</p> <p>Specify size.</p> <p>Specify size.</p> <p>Specify size.</p> <p>Specify size.</p>
Corner Type	<ul style="list-style-type: none"> • Rounded corners • Square corners 	<p>No cost</p> <p>No cost</p>	<p>Specify <i>with rounded corners</i>.</p> <p>Specify <i>with square corners</i>.</p>

	Options	U.S Price	Required to Specify
Surface Materials	<p>Table top</p> <ul style="list-style-type: none"> • High-Pressure Laminate <ul style="list-style-type: none"> – 18⁷/₈"D x 18⁷/₈"W – 20"D x 36"W – 28³/₄"D x 28³/₄"W – 24"D x 54"W – 28³/₄"D x 60"W • Open Line laminate • Wood veneer <ul style="list-style-type: none"> – 18⁷/₈"D x 18⁷/₈"W – 20"D x 36"W – 28³/₄"D x 28³/₄"W – 24"D x 54"W – 28³/₄"D x 60"W • Premium wood 2 <ul style="list-style-type: none"> – 18⁷/₈"D x 18⁷/₈"W – 20"D x 36"W – 28³/₄"D x 28³/₄"W – 24"D x 54"W – 28³/₄"D x 60"W • Premium wood 3 <ul style="list-style-type: none"> – 18⁷/₈"D x 18⁷/₈"W – 20"D x 36"W – 28³/₄"D x 28³/₄"W – 24"D x 54"W – 28³/₄"D x 60"W • Customiz stain • Full-fill finish <ul style="list-style-type: none"> – 18⁷/₈"D x 18⁷/₈"W – 20"D x 36"W – 28³/₄"D x 28³/₄"W – 24"D x 54"W – 28³/₄"D x 60"W 	<p>+\$ 67</p> <p>+\$ 70</p> <p>+\$ 70</p> <p>+\$ 74</p> <p>+\$ 77</p> <p>+\$ 71 plus cost of laminate</p> <p>+\$402</p> <p>+\$417</p> <p>+\$417</p> <p>+\$442</p> <p>+\$460</p> <p>+\$436</p> <p>+\$452</p> <p>+\$452</p> <p>+\$479</p> <p>+\$499</p> <p>+\$469</p> <p>+\$487</p> <p>+\$487</p> <p>+\$516</p> <p>+\$538</p> <p>No cost</p> <p>+\$536</p> <p>+\$556</p> <p>+\$556</p> <p>+\$589</p> <p>+\$614</p>	<p>Specify High-Pressure Laminate color number.</p> <p>Specify High-Pressure Laminate color number.</p> <p>Specify High-Pressure Laminate color number.</p> <p>Specify High-Pressure Laminate color number.</p> <p>Specify High-Pressure Laminate color number.</p> <p>▶ See <i>Surface Materials Reference Manual</i>.</p> <p>Specify wood color number.</p> <p>Specify wood color number.</p> <p>Specify wood color number.</p> <p>Specify wood color number.</p> <p>Specify wood color number.</p> <p>Specify Premium wood 2 finish number.</p> <p>Specify Premium wood 2 finish number.</p> <p>Specify Premium wood 2 finish number.</p> <p>Specify Premium wood 2 finish number.</p> <p>Specify Premium wood 2 finish number.</p> <p>Specify Premium wood 3 finish number.</p> <p>Specify Premium wood 3 finish number.</p> <p>Specify Premium wood 3 finish number.</p> <p>Specify Premium wood 3 finish number.</p> <p>Specify Premium wood 3 finish number.</p> <p>Specify Premium wood 3 finish number.</p> <p>Specify <i>with Customiz stain</i>.</p> <p>▶ See <i>Surface Materials Reference Manual</i>.</p> <p>Specify full-fill finish number.</p> <p>Specify full-fill finish number.</p> <p>Specify full-fill finish number.</p> <p>Specify full-fill finish number.</p> <p>Specify full-fill finish number.</p>

For Canadian Pricing
 Multiply U.S. Price by the Canadian price factor.
 ▶ See page 1 for details.

▶ **Options, continued on next page**

Corian and glass for Bassline tables will be available Fall 2018.

► Options, continued from previous page

Tip: Glass and Corian are only available with rounded corners.

Options	U.S Price	Required to Specify
Surface Materials, continued		
• Glass		
– 18 ⁷ / ₈ "D x 18 ⁷ / ₈ "W	+\$ 748	Specify glass color number.
– 20"D x 36"W	+\$1318	Specify glass color number.
– 28 ³ / ₄ "D x 28 ³ / ₄ "W	+\$1323	Specify glass color number.
– 24"D x 54"W	+\$1450	Specify glass color number.
– 28 ³ / ₄ "D x 60"W	+\$1596	Specify glass color number.
• Corian		
– 18 ⁷ / ₈ "D x 18 ⁷ / ₈ "W	+\$1280	Specify Corian color number.
– 20"D x 36"W	+\$1639	Specify Corian color number.
– 28 ³ / ₄ "D x 28 ³ / ₄ "W	+\$1644	Specify Corian color number.
– 24"D x 54"W	+\$1904	Specify Corian color number.
– 28 ³ / ₄ "D x 60"W	+\$1935	Specify Corian color number.
Base		
• Paint price group 1	No cost	Specify paint color number.
• Paint price group 2	+\$ 36	Specify paint color number.
• Paint price group 3	+\$ 72	Specify paint color number.
• Lux Coatings	+\$ 206	Specify Lux Coatings color number.

Specification Information

• Style Number	• Dimensions		• U.S. Base Price
	• D	• W	
TSBLNTRS	18 ⁷ / ₈ "	18 ⁷ / ₈ "	\$663
	20"	36"	\$689
	28 ³ / ₄ "	28 ³ / ₄ "	\$689
	24"	54"	\$729
	28 ³ / ₄ "	60"	\$760

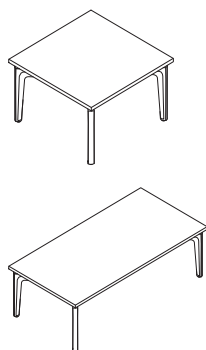

For Canadian Pricing
Multiply U.S. Price by the Canadian price factor.
► See page 1 for details.

Round Tables

Corian and glass for Bassline tables will be available Fall 2018.



	Standard Includes	Required to Specify
<ul style="list-style-type: none"> ▶ Need help? Product details, page 260 	<ul style="list-style-type: none"> • 3/4"-thick table top: Low-Pressure Laminate • 3 mm edge band: default color to match laminate • Base: paint price group 1 • Glides • Ships ready to assemble 	<ol style="list-style-type: none"> 1 Style number 2 Size (see below under Required Selections) 3 Laminate color number for table top 4 Paint color number for base 5 Options, if selected (see below) <p>▶ See <i>Surface Materials</i>, page 298.</p>

	Required Selections	U.S Price	Required to Specify
Size	<ul style="list-style-type: none"> • 25" diameter • 39" diameter 	<p>Prices below</p> <p>Prices below</p>	<p>Specify size.</p> <p>Specify size.</p>

	Options	U.S Price	Required to Specify
Surface Materials	Table top		
	• High-Pressure Laminate		
	– 25" diameter	+\$ 67	Specify High-Pressure Laminate color number.
	– 39" diameter	+\$ 73	Specify High-Pressure Laminate color number.
	• Open Line laminate	+\$ 71 plus cost of laminate	▶ See <i>Surface Materials Reference Manual</i> .
	• Wood veneer		Specify wood color number.
	– 25" diameter	+\$ 402	Specify wood color number.
	– 39" diameter	+\$ 436	
	• Premium wood 2		Specify Premium wood 2 finish number.
	– 25" diameter	+\$ 436	Specify Premium wood 2 finish number.
	– 39" diameter	+\$ 472	
	• Premium wood 3		Specify Premium wood 3 finish number.
	– 25" diameter	+\$ 469	Specify Premium wood 3 finish number.
	– 39" diameter	+\$ 509	Specify with <i>Customiz stain</i> .
	• Customiz stain	No cost	▶ See <i>Surface Materials Reference Manual</i> .
• Full-fill finish		Specify full-fill finish number.	
– 25" diameter	+\$ 536	Specify full-fill finish number.	
– 39" diameter	+\$ 581		
• Glass		Specify glass color number.	
– 25" diameter	+\$ 751	Specify glass color number.	
– 39" diameter	+\$ 818		
• Corian		Specify Corian color number.	
– 25" diameter	+\$1280	Specify Corian color number.	
– 39" diameter	+\$1322		
	Base		
	• Paint price group 1	No cost	Specify paint color number.
	• Paint price group 2	+\$ 36	Specify paint color number.
	• Paint price group 3	+\$ 72	Specify paint color number.
	• Lux Coatings	+\$ 206	Specify Lux Coatings color number.

Tip: Wood veneer tables have matching flat veneer profile edges.

Specification Information		
• Style Number	• Diameter	• U.S. Base Price
TSBLNTRD	25"	\$663
	39"	\$719

For Canadian Pricing
 Multiply U.S. Price by the Canadian price factor.
 ▶ See page 1 for details.

Oval Tables

Corian and glass for Bassline tables will be available Fall 2018.

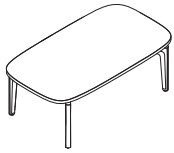

Standard Includes	Required to Specify
<ul style="list-style-type: none"> ▶ Need help? Product details, page 260 • ¾"-thick table top: Low-Pressure Laminate • 3 mm edge band: default color to match laminate • Base: paint price group 1 • Glides • Ships ready to assemble 	<ol style="list-style-type: none"> 1 Style number 2 Size (see below under Required Selections) 3 Laminate color number for table top 4 Paint color number for base 5 Options, if selected (see below) <ul style="list-style-type: none"> ▶ See <i>Surface Materials</i>, page 298.

Required Selections	U.S Price	Required to Specify
Size		
• 20"D x 36"W	Prices at right	Specify size.
• 24"D x 54"W	Prices at right	Specify size.
• 28¾"D x 60"W	Prices at right	Specify size.

Options	U.S Price	Required to Specify
Surface Materials		
Table top		
• High-Pressure Laminate		
– 20"D x 36"W	+\$ 73	Specify High-Pressure Laminate color number.
– 24"D x 54"W	+\$ 77	Specify High-Pressure Laminate color number.
– 28¾"D x 60"W	+\$ 80	Specify High-Pressure Laminate color number.
• Open Line laminate	+\$ 71 plus cost of laminate	▶ See <i>Surface Materials Reference Manual</i> .
• Wood veneer		
– 20"D x 36"W	+\$ 441	Specify wood color number.
– 24"D x 54"W	+\$ 464	Specify wood color number.
– 28¾"D x 60"W	+\$ 483	Specify wood color number.
• Premium wood 2		
– 20"D x 36"W	+\$ 478	Specify Premium wood 2 finish number.
– 24"D x 54"W	+\$ 503	Specify Premium wood 2 finish number.
– 28¾"D x 60"W	+\$ 523	Specify Premium wood 2 finish number.
• Premium wood 3		
– 20"D x 36"W	+\$ 515	Specify Premium wood 3 finish number.
– 24"D x 54"W	+\$ 542	Specify Premium wood 3 finish number.
– 28¾"D x 60"W	+\$ 564	Specify Premium wood 3 finish number.
• Customiz stain	No cost	Specify with <i>Customiz stain</i> .
		▶ See <i>Surface Materials Reference Manual</i> .
• Full-fill finish		
– 20"D x 36"W	+\$ 588	Specify full-fill finish number.
– 24"D x 54"W	+\$ 619	Specify full-fill finish number.
– 28¾"D x 60"W	+\$ 645	Specify full-fill finish number.
• Glass		
– 20"D x 36"W	+\$1028	Specify glass color number.
– 24"D x 54"W	+\$1591	Specify glass color number.
– 28¾"D x 60"W	+\$1673	Specify glass color number.
• Corian		
– 20"D x 36"W	+\$1431	Specify Corian color number.
– 24"D x 54"W	+\$1868	Specify Corian color number.
– 28¾"D x 60"W	+\$1930	Specify Corian color number.
Base		
• Paint price group 1	No cost	Specify paint color number.
• Paint price group 2	+\$ 36	Specify paint color number.
• Paint price group 3	+\$ 72	Specify paint color number.
• Lux Coatings	+\$ 206	Specify Lux Coatings color number.

Tip: Wood veneer tables have matching flat veneer profile edges.

 **For Canadian Pricing**
 Multiply U.S. Price by the Canadian price factor.
 ▶ See page 1 for details.

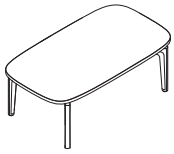

Specification Information			
Style Number	Dimensions		U.S. Base Price
	D	W	
TSBLNTOV	20"	36"	\$728
	24"	54"	\$766
	28 ³ / ₄ "	60"	\$797

 **For Canadian Pricing**
 Multiply U.S. Price by the Canadian price factor.
 ▶ See page 1 for details.

Racetrack Tables

Corian and glass for Bassline tables will be available Fall 2018.

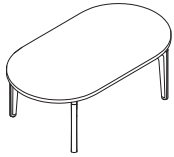

	Standard Includes	Required to Specify
<p>▶ Need help? Product details, page 260</p>	<ul style="list-style-type: none"> • ¾"-thick table top: Low-Pressure Laminate • 3 mm edge band: default color to match laminate • Base: paint price group 1 • Glides • Ships ready to assemble 	<ol style="list-style-type: none"> 1 Style number 2 Size (see below under Required Selections) 3 Laminate color number for table top 4 Paint color number for base 5 Options, if selected (see below) <p>▶ See <i>Surface Materials</i>, page 298.</p>

	Required Selections	U.S Price	Required to Specify
Size	<ul style="list-style-type: none"> • 20"D x 36"W • 24"D x 54"W • 28¾"D x 60"W 	<p>Prices at right</p> <p>Prices at right</p> <p>Prices at right</p>	<p>Specify size.</p> <p>Specify size.</p> <p>Specify size.</p>

	Options	U.S Price	Required to Specify
Surface Materials	Table top		
	<ul style="list-style-type: none"> • High-Pressure Laminate <ul style="list-style-type: none"> – 20"D x 36"W – 24"D x 54"W – 28¾"D x 60"W • Open Line laminate • Wood veneer <ul style="list-style-type: none"> – 20"D x 36"W – 24"D x 54"W – 28¾"D x 60"W • Premium wood 2 <ul style="list-style-type: none"> – 20"D x 36"W – 24"D x 54"W – 28¾"D x 60"W • Premium wood 3 <ul style="list-style-type: none"> – 20"D x 36"W – 24"D x 54"W – 28¾"D x 60"W • Customiz stain • Full-fill finish <ul style="list-style-type: none"> – 20"D x 36"W – 24"D x 54"W – 28¾"D x 60"W • Glass <ul style="list-style-type: none"> – 20"D x 36"W – 24"D x 54"W – 28¾"D x 60"W • Corian <ul style="list-style-type: none"> – 20"D x 36"W – 24"D x 54"W – 28¾"D x 60"W 	<p>+\$ 73</p> <p>+\$ 77</p> <p>+\$ 80</p> <p>+\$ 71 plus cost of laminate</p> <p>+\$ 441</p> <p>+\$ 464</p> <p>+\$ 483</p> <p>+\$ 478</p> <p>+\$ 503</p> <p>+\$ 523</p> <p>+\$ 515</p> <p>+\$ 542</p> <p>+\$ 564</p> <p>No cost</p> <p>+\$ 588</p> <p>+\$ 619</p> <p>+\$ 645</p> <p>+\$1028</p> <p>+\$1591</p> <p>+\$1673</p> <p>+\$1431</p> <p>+\$1868</p> <p>+\$1930</p>	<p>Specify High-Pressure Laminate color number.</p> <p>Specify High-Pressure Laminate color number.</p> <p>Specify High-Pressure Laminate color number.</p> <p>▶ See <i>Surface Materials Reference Manual</i>.</p> <p>Specify wood color number.</p> <p>Specify wood color number.</p> <p>Specify wood color number.</p> <p>Specify Premium wood 2 finish number.</p> <p>Specify Premium wood 2 finish number.</p> <p>Specify Premium wood 2 finish number.</p> <p>Specify Premium wood 3 finish number.</p> <p>Specify Premium wood 3 finish number.</p> <p>Specify Premium wood 3 finish number.</p> <p>Specify <i>with Customiz stain</i>.</p> <p>▶ See <i>Surface Materials Reference Manual</i>.</p> <p>Specify full-fill finish number.</p> <p>Specify full-fill finish number.</p> <p>Specify full-fill finish number.</p> <p>Specify glass color number.</p> <p>Specify glass color number.</p> <p>Specify glass color number.</p> <p>Specify Corian color number.</p> <p>Specify Corian color number.</p> <p>Specify Corian color number.</p>
	Base		
	<ul style="list-style-type: none"> • Paint price group 1 • Paint price group 2 • Paint price group 3 • Lux Coatings 	<p>No cost</p> <p>+\$ 36</p> <p>+\$ 72</p> <p>+\$ 206</p>	<p>Specify paint color number.</p> <p>Specify paint color number.</p> <p>Specify paint color number.</p> <p>Specify Lux Coatings color number.</p>

Tip: Wood veneer tables have matching flat veneer profile edges.

For Canadian Pricing
 Multiply U.S. Price by the Canadian price factor.
 ▶ See page 1 for details.

Specification Information

Style Number	Dimensions		U.S. Base Price
	D	W	
TSBLNTRT	20"	36"	\$728
	24"	54"	\$766
	28 ³ / ₄ "	60"	\$797

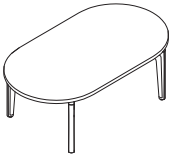

 **For Canadian Pricing**
 Multiply U.S. Price by the Canadian price factor.
 ▶ See page 1 for details.

Three Leg Tables

Corian and glass for Bassline tables will be available Fall 2018.



Standard Includes	Required to Specify
<ul style="list-style-type: none"> ▶ Need help? Product details, page 264 • 3/4"-thick table top: Low-Pressure Laminate • 3 mm edge band: default color to match laminate • Base: paint price group 1 • Glides • Ships ready to assemble 	<ul style="list-style-type: none"> 1 Style number 2 Laminate color number for table top 3 Paint color number for base 4 Options, if selected (see below) ▶ See <i>Surface Materials</i>, page 298.

Tip: Wood veneer tables have matching flat veneer profile edges.

Options	U.S. Price	Required to Specify
Surface Materials		
Table top		
• High-Pressure Laminate		
– Small	+\$ 68	Specify High-Pressure Laminate color number.
– Medium	+\$ 70	Specify High-Pressure Laminate color number.
– Large	+\$ 75	Specify High-Pressure Laminate color number.
• Open Line laminate	+\$ 71 plus cost of laminate	▶ See <i>Surface Materials Reference Manual</i> .
• Wood veneer		
– Small	+\$408	Specify wood color number.
– Medium	+\$421	Specify wood color number.
– Large	+\$447	Specify wood color number.
• Premium wood 2		
– Small	+\$521	Specify Premium wood 2 finish number.
– Medium	+\$530	Specify Premium wood 2 finish number.
– Large	+\$552	Specify Premium wood 2 finish number.
• Premium wood 3		
– Small	+\$566	Specify Premium wood 3 finish number.
– Medium	+\$572	Specify Premium wood 3 finish number.
– Large	+\$603	Specify Premium wood 3 finish number.
• Customiz stain	No cost	Specify <i>with Customiz stain</i> .
		▶ See <i>Surface Materials Reference Manual</i> .
• Full-fill finish		
– Small	+\$598	Specify full-fill finish number.
– Medium	+\$601	Specify full-fill finish number.
– Large	+\$645	Specify full-fill finish number.
• Glass		
– Small	+\$798	Specify glass color number.
– Medium	+\$800	Specify glass color number.
– Large	+\$874	Specify glass color number.
• Corian		
– Small	+\$816	Specify Corian color number.
– Medium	+\$842	Specify Corian color number.
– Large	+\$894	Specify Corian color number.
Base		
• Paint price group 1	No cost	Specify paint color number.
• Paint price group 2	+\$ 36	Specify paint color number.
• Paint price group 3	+\$ 72	Specify paint color number.
• Lux Coatings	+\$206	Specify Lux Coatings color number.



For Canadian Pricing
 Multiply U.S. Price by the Canadian price factor.
 ▶ See page 1 for details.

Tip: Overall table height is 13" including the base and table top.

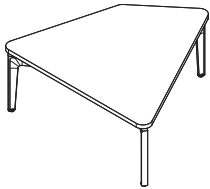

Specification Information

• Style	• U.S.
• Number	• Base
•	• Price

Small Three Leg Table

TSBLNT3LEGS \$680

Medium Three Leg Table

TSBLNT3LEGM \$702

Large Three Leg Table

TSBLNT3LEGL \$745

 **For Canadian Pricing**
 Multiply U.S. Price by the Canadian price factor.
 ▶ See page 1 for details.

Box Top Tables



Tip: Overall table width is 18".

Tip: Wood veneer tables have matching flat veneer profile edges.

Standard Includes		Required to Specify
<ul style="list-style-type: none"> ▶ Need help? Product details, page 268 	<ul style="list-style-type: none"> • 3/4"-thick table top: Low-Pressure Laminate • 3 mm edge band: default color to match laminate • Base: paint price group 1 • Metal accent panel: paint price group 1 • Glides • Ships ready to assemble 	<ol style="list-style-type: none"> 1 Style number 2 Size (see below under Required Selections) 3 Laminate color number for table top 4 Paint color number for base 5 Paint color number for metal accent panel 6 Options, if selected (see below) <p>▶ See <i>Surface Materials</i>, page 298.</p>

Required Selections	U.S. Price	Required to Specify
Size		
• 25"D x 18"H	Prices at right	Specify size.
• 25"D x 23"H	Prices at right	Specify size.
• 30"D x 18"H	Prices at right	Specify size.
• 30"D x 23"H	Prices at right	Specify size.

Options	U.S. Price	Required to Specify
Surface Materials		
Table top		
• High-Pressure Laminate		
– 25"D x 18"H	+\$ 77	Specify High-Pressure Laminate color number.
– 25"D x 23"H	+\$ 80	Specify High-Pressure Laminate color number.
– 30"D x 18"H	+\$ 80	Specify High-Pressure Laminate color number.
– 30"D x 23"H	+\$ 85	Specify High-Pressure Laminate color number.
• Open Line laminate	+\$ 71 plus cost of laminate	▶ See <i>Surface Materials Reference Manual</i> .
• Wood veneer		
– 25"D x 18"H	+\$541	Specify wood color number.
– 25"D x 23"H	+\$580	Specify wood color number.
– 30"D x 18"H	+\$571	Specify wood color number.
– 30"D x 23"H	+\$602	Specify wood color number.
• Premium wood 2		
– 25"D x 18"H	+\$665	Specify Premium wood 2 finish number.
– 25"D x 23"H	+\$713	Specify Premium wood 2 finish number.
– 30"D x 18"H	+\$702	Specify Premium wood 2 finish number.
– 30"D x 23"H	+\$740	Specify Premium wood 2 finish number.
• Premium wood 3		
– 25"D x 18"H	+\$725	Specify Premium wood 3 finish number.
– 25"D x 23"H	+\$778	Specify Premium wood 3 finish number.
– 30"D x 18"H	+\$766	Specify Premium wood 3 finish number.
– 30"D x 23"H	+\$807	Specify Premium wood 3 finish number.
• Customiz stain	No cost	Specify <i>with Customiz stain</i> .
		▶ See <i>Surface Materials Reference Manual</i> .
• Full-fill finish		
– 25"D x 18"H	+\$665	Specify full-fill finish number.
– 25"D x 23"H	+\$713	Specify full-fill finish number.
– 30"D x 18"H	+\$702	Specify full-fill finish number.
– 30"D x 23"H	+\$740	Specify full-fill finish number.
Base		
• Paint price group 1	No cost	Specify paint color number.
• Paint price group 2	+\$ 36	Specify paint color number.
• Paint price group 3	+\$ 72	Specify paint color number.
• Lux Coatings	+\$206	Specify Lux Coatings color number.

▶ Options, continued on next page

 **For Canadian Pricing**
 Multiply U.S. Price by the Canadian price factor.
 ▶ See page 1 for details.

► Options, continued from previous page

Options	U.S. Price	Required to Specify
Surface Materials, continued Metal accent panel <ul style="list-style-type: none"> • Paint price group 1 • Paint price group 2 • Paint price group 3 	No cost +\$36 +\$72	Specify paint color number. Specify paint color number. Specify paint color number.
Metal Accent Panel Design <ul style="list-style-type: none"> • No design • With design 	No cost +\$25	Specify <i>with no design</i> . Specify <i>with design</i> .
Related Products <ul style="list-style-type: none"> • Power 		► Page 296

Tip: The optional design is applied to the metal accent panel when specified.

Specification Information

Style Number	Dimensions		U.S. Base Price
	D	H	
TSBLNTBX	25"	18"	\$768
	25"	23"	\$799
	30"	18"	\$799
	30"	23"	\$849



 **For Canadian Pricing**
 Multiply U.S. Price by the Canadian price factor.
 ► See page 1 for details.

Box Top Coffee Table

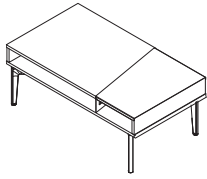

Tip: Wood veneer tables have matching flat veneer profile edges.

Tip: The optional design is applied to the metal accent panel when specified.

Tip: Overall table height is 18" including the base and table top.

Standard Includes		Required to Specify
<ul style="list-style-type: none"> ▶ Need help? Product details, page 268 	<ul style="list-style-type: none"> • 3/4"-thick table top: Low-Pressure Laminate • 3 mm edge band: default color to match laminate • Base: paint price group 1 • Metal accent panel: paint price group 1 • Glides • Ships ready to assemble 	<ol style="list-style-type: none"> 1 Style number 2 Laminate color number for table top 3 Paint color number for base 4 Paint color number for metal accent panel 5 Options, if selected (see below) <p>▶ See <i>Surface Materials</i>, page 298.</p>

Options	U.S. Price	Required to Specify
Surface Materials		
<ul style="list-style-type: none"> • Table top • High-Pressure Laminate • Open Line laminate • Wood veneer • Premium wood 2 • Premium wood 3 • Customiz stain • Full-fill finish 	<ul style="list-style-type: none"> +\$ 94 +\$ 71 plus cost of laminate +\$1034 +\$1271 +\$1386 No cost +\$1271 	<ul style="list-style-type: none"> Specify High-Pressure Laminate color number. ▶ See <i>Surface Materials Reference Manual</i>. Specify wood color number. Specify Premium wood 2 finish number. Specify Premium wood 3 finish number. Specify with <i>Customiz stain</i>. ▶ See <i>Surface Materials Reference Manual</i>. Specify full-fill finish number.
Base		
<ul style="list-style-type: none"> • Paint price group 1 • Paint price group 2 • Paint price group 3 • Lux Coatings 	<ul style="list-style-type: none"> No cost +\$ 36 +\$ 72 +\$ 206 	<ul style="list-style-type: none"> Specify paint color number. Specify paint color number. Specify paint color number. Specify Lux Coatings color number.
Metal accent panel		
<ul style="list-style-type: none"> • Paint price group 1 • Paint price group 2 • Paint price group 3 	<ul style="list-style-type: none"> No cost +\$ 36 +\$ 72 	<ul style="list-style-type: none"> Specify paint color number. Specify paint color number. Specify paint color number.
Metal Accent Panel Design		
<ul style="list-style-type: none"> • No design • With design 	<ul style="list-style-type: none"> No cost +\$ 25 	<ul style="list-style-type: none"> Specify with <i>no design</i>. Specify with <i>design</i>.

Specification Information				
Dimensions			Style	U.S.
D	W	H	Number	Base Price
25"	54"	18"	TSBLNTBXC	\$938
.

 **For Canadian Pricing**
 Multiply U.S. Price by the Canadian price factor.
 ▶ See page 1 for details.

Box Top Tables with Bag Drop



Standard Includes	Required to Specify
<ul style="list-style-type: none"> ▶ Need help? Product details, page 268 • 3/4"-thick table top: Low-Pressure Laminate • 3 mm edge band: default color to match laminate • Base: paint price group 1 • Metal accent panel: paint price group 1 • Glides • Ships ready to assemble 	<ol style="list-style-type: none"> 1 Style number 2 Size (see below under Required Selections) 3 Laminate color number for table top 4 Paint color number for base 5 Paint color number for metal accent panel 6 Options, if selected (see below) <p>▶ See <i>Surface Materials</i>, page 298.</p>

Required Selections	U.S. Price	Required to Specify
Size		
• 25"D x 23"H	Prices at right	Specify size.
• 30"D x 23"H	Prices at right	Specify size.

Options	U.S. Price	Required to Specify
Surface Materials		
Table top		
• High-Pressure Laminate		
– 25"D x 23"H	+\$ 92	Specify High-Pressure Laminate color number.
– 30"D x 23"H	+\$ 94	Specify High-Pressure Laminate color number.
• Open Line laminate	+\$ 71 plus cost of laminate	▶ See <i>Surface Materials Reference Manual</i> .
• Wood veneer		
– 25"D x 23"H	+\$551	Specify wood color number.
– 30"D x 23"H	+\$576	Specify wood color number.
• Premium wood 2		
– 25"D x 23"H	+\$678	Specify Premium wood 2 finish number.
– 30"D x 23"H	+\$709	Specify Premium wood 2 finish number.
• Premium wood 3		
– 25"D x 23"H	+\$739	Specify Premium wood 3 finish number.
– 30"D x 23"H	+\$772	Specify Premium wood 3 finish number.
• Customiz stain	No cost	Specify <i>with Customiz stain</i> .
		▶ See <i>Surface Materials Reference Manual</i> .
• Full-fill finish		
– 25"D x 23"H	+\$678	Specify full-fill finish number.
– 30"D x 23"H	+\$709	Specify full-fill finish number.
Base		
• Paint price group 1	No cost	Specify paint color number.
• Paint price group 2	+\$ 36	Specify paint color number.
• Paint price group 3	+\$ 72	Specify paint color number.
• Lux Coatings	+\$206	Specify Lux Coatings color number.
Metal accent panel		
• Paint price group 1	No cost	Specify paint color number.
• Paint price group 2	+\$ 36	Specify paint color number.
• Paint price group 3	+\$ 72	Specify paint color number.
Metal Accent Panel Design		
• No design	No cost	Specify <i>with no design</i> .
• With design	+\$ 25	Specify <i>with design</i> .
Related Products	• Power	▶ Page 296

Tip: Wood veneer tables have matching flat veneer profile edges.

Tip: The optional design is applied to the metal accent panel when specified.



For Canadian Pricing
 Multiply U.S. Price by the Canadian price factor.
 ▶ See page 1 for details.

Specification Information

Style Number	Dimensions		U.S. Base Price
	D	H	
TSBLNTBxB	25"	23"	\$919
	30"	23"	\$939



Tip: Overall table width is 18".

Tip: Size of bag drop opening is the same for both 25"D and 30"D tables.



For Canadian Pricing
Multiply U.S. Price by the Canadian price factor.
▶ See page 1 for details.

One Seat Bench



Tip: All benches have a diagonal seam, regardless if they are solid or multicolor.



Tip: Multicolor seats have contrasting color within the same fabric family. (For example, 5H16 specified on front and 5H19 specified on back; both are Billiard Multi-Use by DesignTex.)

Standard Includes	Required to Specify
<ul style="list-style-type: none"> ▶ Need help? Product details, page 270 • Upholstered seat: fabric price group 1 • Base: paint price group 1 • Side table, if selected: Low-Pressure Laminate 	<ol style="list-style-type: none"> 1 Style number 2 Color scheme (see below under Required Selections) 3 Fabric color number for seat 4 Paint color number for base 5 Low-Pressure Laminate color number for side table, if selected 6 Options, if selected (see below) <p>▶ See <i>Surface Materials</i>, page 298.</p>

Color Scheme	Required Selections	U.S. Price	Required to Specify
	<ul style="list-style-type: none"> • Solid seat • Multicolor seat 	<ul style="list-style-type: none"> No cost +\$ 50 	<ul style="list-style-type: none"> Specify solid seat color scheme. Specify multicolor seat color scheme.

Surface Materials	Options	U.S. Price	Required to Specify
	<p>Solid seat</p> <ul style="list-style-type: none"> • Fabric price group 1 • Fabric price group 2 • Fabric price group 3 • Fabric price group 4 • Fabric price group 5 • Fabric price group 6 • Fabric price group 7 • Fabric price group 8 • Fabric price group 9 • Fabric price group 10 • Steelcase leather • Elmosoft leather • Customer's Own Material (COM) • Customer's Own Leather (COL) 	<ul style="list-style-type: none"> No cost +\$ 12 +\$ 27 +\$ 36 +\$ 47 +\$ 69 +\$ 94 +\$121 +\$145 +\$170 +\$190 +\$200 +\$ 38 +\$ 38 	<ul style="list-style-type: none"> Specify fabric color number. Specify fabric color number. Specify fabric color number. Specify fabric color number. Specify fabric color number. Specify fabric color number. Specify fabric color number. Specify fabric color number. Specify fabric color number. Specify fabric color number. Specify leather color number. Specify Elmosoft leather color number. ▶ See <i>Understanding Customer's Own Material (COM)</i>, page 299. ▶ See <i>Understanding Customer's Own Material (COL)</i>, page 299.
	<p>Multicolor seat</p> <ul style="list-style-type: none"> • Fabric price group 1 • Fabric price group 2 • Fabric price group 3 • Fabric price group 4 • Fabric price group 5 • Fabric price group 6 • Fabric price group 7 • Fabric price group 8 • Fabric price group 9 • Fabric price group 10 • Steelcase leather • Elmosoft leather • Customer's Own Material (COM) • Customer's Own Leather (COL) 	<ul style="list-style-type: none"> No cost +\$ 24 +\$ 54 +\$ 72 +\$ 94 +\$138 +\$188 +\$242 +\$290 +\$340 +\$380 +\$400 +\$ 38 +\$ 38 	<ul style="list-style-type: none"> Specify fabric color number. Specify fabric color number. Specify fabric color number. Specify fabric color number. Specify fabric color number. Specify fabric color number. Specify fabric color number. Specify fabric color number. Specify fabric color number. Specify fabric color number. Specify leather color number. Specify Elmosoft leather color number. ▶ See <i>Understanding Customer's Own Material (COM)</i>, page 299. ▶ See <i>Understanding Customer's Own Material (COL)</i>, page 299.
	<p>Base</p> <ul style="list-style-type: none"> • Paint price group 1 • Paint price group 2 • Paint price group 3 • Lux Coatings 	<ul style="list-style-type: none"> No cost +\$ 36 +\$ 72 +\$206 	<ul style="list-style-type: none"> Specify paint color number. Specify paint color number. Specify paint color number. Specify Lux Coatings color number.
	<p>Laminate side table</p> <ul style="list-style-type: none"> • Low-Pressure Laminate • High-Pressure Laminate • Open Line laminate 	<ul style="list-style-type: none"> No cost +\$ 78 +\$ 71 plus cost of laminate 	<ul style="list-style-type: none"> Specify Low-Pressure Laminate color number. Specify High-Pressure Laminate color number. ▶ See <i>Surface Materials Reference Manual</i>.

▶ Options, continued on next page



For Canadian Pricing
Multiply U.S. Price by the Canadian price factor.
▶ See page 1 for details.

► Options, continued from previous page

Options	U.S. Price	Required to Specify
Surface Materials, continued Wood veneer side table <ul style="list-style-type: none"> • Wood veneer • Premium wood 2 • Premium wood 3 • Customiz stain 	+\$471 +\$512 +\$545 No cost	Specify wood color number. Specify Premium wood 2 finish number. Specify Premium wood 3 finish number. Specify with <i>Customiz stain</i> . ► See <i>Surface Materials Reference Manual</i> Specify full-finish color number.
<ul style="list-style-type: none"> • Full-fill finish 	+\$598	
Thread Color Scheme <ul style="list-style-type: none"> • Non-contrasting • Contrasting 	No cost +\$ 25	Specify with non-contrasting. Specify with <i>contrasting</i> and select thread color number.
Side Table <ul style="list-style-type: none"> • No table • With table 	No cost +\$125	Specify without table. Specify with table.

Tip: Thread color defaults to align with the lightest color on the seat unless contrasting thread is selected.

Tip: Contrasting thread option is only available on solid seats.

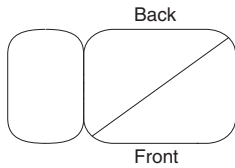

Tip: Side table is always installed on the right side of the bench.

Specification Information

Style Number	Dimension			U.S. Base Price
	D	W	H	
Solid Seat				
TSBLNS1	18"	24"	17¼"	\$715



 **For Canadian Pricing**
 Multiply U.S. Price by the Canadian price factor.
 ► See page 1 for details.

Two Seat Bench

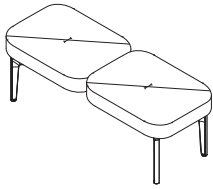

Tip: All benches have a diagonal seam, regardless if they are solid or multi-color.

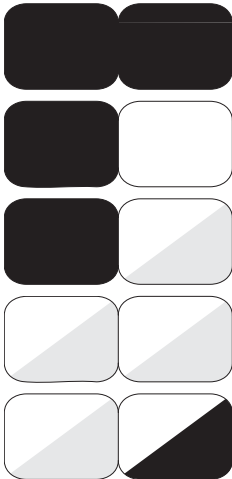

Tip: Contrasting solid seats can have contrasting color from two different fabric families. (For example, 5H16 specified on left from Billiard Multi-Use by Designtex and 5F16 specified on right from Buzz2.)

Tip: Multicolor seats have contrasting color within the same fabric family. (For example, 5H16 specified on front and 5H19 specified on back; both are Billiard Multi-Use by Designtex.)

Tip: Customer's Own Material (COM) and Customer's Own Leather (COL) will only be charged once per style and not per seat. If seats are contrasting, you will get charged for either (COM) or (COL), but not both.



For Canadian Pricing
Multiply U.S. Price by the Canadian price factor.
▶ See page 1 for details.

Standard Includes		Required to Specify
▶ Need help? Product details, page 270	<ul style="list-style-type: none"> Two upholstered seats: fabric price group 1 Base: paint price group 1 	<ol style="list-style-type: none"> Style number Color scheme (see below under Required Selections) Fabric color number for seats Paint color number for base Options, if selected (see below) <p>▶ See <i>Surface Materials</i>, page 298.</p>

Required Selections	U.S. Price	Required to Specify
Color Scheme		
• Solid, non-contrasting seats	No cost	Specify solid non-contrasting seat color scheme.
• Solid, contrasting seats	+\$ 25	Specify solid contrasting seat color scheme.
• One solid seat, one multicolor seat	+\$ 50	Specify one solid, one multicolor seat color scheme.
• Multicolor, non-contrasting seats	+\$100	Specify multicolor non-contrasting seat color scheme.
• Multicolor, contrasting seats	+\$100	Specify multicolor contrasting seat color scheme.

Options	U.S. Price	Required to Specify
Surface Materials		
Solid seat		
• Fabric price group 1	No cost	Specify fabric color number.
• Fabric price group 2	+\$ 12 per seat	Specify fabric color number.
• Fabric price group 3	+\$ 27 per seat	Specify fabric color number.
• Fabric price group 4	+\$ 36 per seat	Specify fabric color number.
• Fabric price group 5	+\$ 47 per seat	Specify fabric color number.
• Fabric price group 6	+\$ 69 per seat	Specify fabric color number.
• Fabric price group 7	+\$ 94 per seat	Specify fabric color number.
• Fabric price group 8	+\$121 per seat	Specify fabric color number.
• Fabric price group 9	+\$145 per seat	Specify fabric color number.
• Fabric price group 10	+\$170 per seat	Specify fabric color number.
• Steelcase leather	+\$190 per seat	Specify leather color number.
• Elmosoft leather	+\$200 per seat	Specify Elmosoft leather color number.
• Customer's Own Material (COM)	+\$ 38	▶ See <i>Understanding Customer's Own Material (COM)</i> , page 299.
• Customer's Own Leather (COL)	+\$ 38	▶ See <i>Understanding Customer's Own Material (COL)</i> , page 299
Multicolor seat		
• Fabric price group 1	No cost	Specify fabric color number.
• Fabric price group 2	+\$ 24 per seat	Specify fabric color number.
• Fabric price group 3	+\$ 54 per seat	Specify fabric color number.
• Fabric price group 4	+\$ 72 per seat	Specify fabric color number.
• Fabric price group 5	+\$ 94 per seat	Specify fabric color number.
• Fabric price group 6	+\$138 per seat	Specify fabric color number.
• Fabric price group 7	+\$188 per seat	Specify fabric color number.
• Fabric price group 8	+\$242 per seat	Specify fabric color number.
• Fabric price group 9	+\$290 per seat	Specify fabric color number.
• Fabric price group 10	+\$340 per seat	Specify fabric color number.
• Steelcase leather	+\$380 per seat	Specify leather color number.
• Elmosoft leather	+\$400 per seat	Specify Elmosoft leather color number.
• Customer's Own Material (COM)	+\$ 38	▶ See <i>Understanding Customer's Own Material (COM)</i> , page 299.
• Customer's Own Leather (COL)	+\$ 38	▶ See <i>Understanding Customer's Own Material (COL)</i> , page 299.
Base		
• Paint price group 1	No cost	Specify paint color number.
• Paint price group 2	+\$ 36	Specify paint color number.
• Paint price group 3	+\$ 72	Specify paint color number.
• Lux Coatings	+\$206	Specify Lux Coatings color number.

▶ Options, continued on next page.

► Options, continued from previous page

	Options	U.S. Price	Required to Specify
Thread Color Scheme	<ul style="list-style-type: none"> • Non-contrasting • Contrasting 	No cost +\$ 25 per seat	Specify with <i>non-contrasting</i> . Specify with <i>contrasting</i> and select thread color number.

Tip: Contrasting thread option is only available on solid non-contrasting.

Tip: Thread color defaults to align with the lightest color on the seat unless contrasting thread is selected.

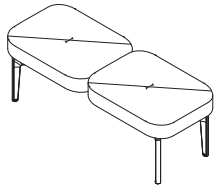

Specification Information				
Style Number	Dimension			U.S. Base Price
	D	W	H	
TSBLNS2	18"	48"	17¼"	\$1216



 **For Canadian Pricing**
 Multiply U.S. Price by the Canadian price factor.
 ► See page 1 for details.

Base-Only Tables

Standard Includes		Required to Specify
<ul style="list-style-type: none"> ▶ Need help? Product details, page 262 	<ul style="list-style-type: none"> • ¾" black Low-Pressure Laminate platform with 3 mm edgeband • Base: paint price group 1 • Glides • Hook and loop fasteners • Hardware pack 	<ol style="list-style-type: none"> 1 Style number 2 Size (see below under Required Selections) 3 Paint color number for base 4 Options, if selected (see below) <p>▶ See <i>Surface Materials</i>, page 298.</p>

Tip: Base-Only Tables have one additional size (22"D x 44"W) for rectangular, oval, and racetrack shapes as compared to the standard tables.

Tip: The platform acts as a shadow underneath your custom top and is 4" less than the standard sizes.

Required Selections	U.S Price	Required to Specify
Square/Rectangular Tables		
• 18 ⁷ / ₈ "D x 18 ⁷ / ₈ "W	Prices below	Specify size.
• 28 ³ / ₄ "D x 28 ³ / ₄ "W	Prices below	Specify size.
• 20"D x 36"W	Prices below	Specify size.
• 22"D x 44"W	Prices below	Specify size.
• 24"D x 54"W	Prices below	Specify size.
• 28 ³ / ₄ "D x 60"W	Prices below	Specify size.
Round Tables		
• 25" diameter	Prices below	Specify size.
• 39" diameter	Prices below	Specify size.
Oval Tables		
• 20"D x 36"W	Prices at right	Specify size.
• 22"D x 44"W	Prices at right	Specify size.
• 24"D x 54"W	Prices at right	Specify size.
• 28 ³ / ₄ "D x 60"W	Prices at right	Specify size.
Racetrack Tables		
• 20"D x 36"W	Prices at right	Specify size.
• 22"D x 44"W	Prices at right	Specify size.
• 24"D x 54"W	Prices at right	Specify size.
• 28 ³ / ₄ "D x 60"W	Prices at right	Specify size.

Options	U.S Price	Required to Specify
Surface Materials		
Base		
• Paint price group 1	No cost	Specify paint color number.
• Paint price group 2	+\$ 36	Specify paint color number.
• Paint price group 3	+\$ 72	Specify paint color number.
• Lux Coatings	+\$206	Specify Lux Coatings color number.

Specification Information			
Style Number	Dimensions D	W	U.S. Base Price

Square/Rectangular Tables			
TSBLNBRSM	18 ⁷ / ₈ "	18 ⁷ / ₈ "	\$630
	28 ³ / ₄ "	28 ³ / ₄ "	\$654
	20"	36"	\$654
	22"	44"	\$693
	24"	54"	\$709
	28 ³ / ₄ "	60"	\$723

▶ **Specification Information, continued on next page**

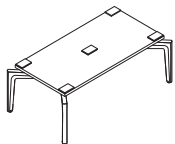

 **For Canadian Pricing**
 Multiply U.S. Price by the Canadian price factor.
 ▶ See page 1 for details.

► Specification Information, continued from previous page

Specification Information

• Style Number	• Dimensions		• U.S. Base Price
	D (Diameter for Round)	W	

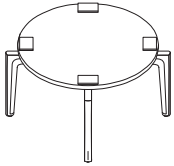

Round Tables

TSBLNBRDM	25"	N.A.	\$630
	39"	N.A.	\$683

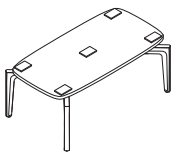

Oval Tables

TSBLNBOVM	20"	36"	\$692
	22"	44"	\$728
	24"	54"	\$743
	28 ³ / ₄ "	60"	\$758

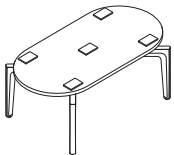

Racetrack Tables

TSBLNBRTM	20"	36"	\$692
	22"	44"	\$728
	24"	54"	\$743
	28 ³ / ₄ "	60"	\$758



For Canadian Pricing
 Multiply U.S. Price by the Canadian price factor.
 ► See page 1 for details.

Power

Round

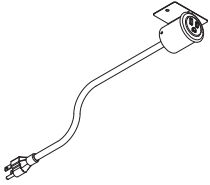

Tip: Box Top Tables and Box Top Tables with Bag Drop have pre-drilled pilot holes in the front and back undersides of the table to accommodate power.

Standard Includes		Required to Specify
<ul style="list-style-type: none"> ▶ Need help? Product details, page 272 	<ul style="list-style-type: none"> • One simplex spill proof receptacle: plastic • Bracket: 7360 Merle • 72" long 15-amp power cord with wall plug • Cable management twist tie • Shipped ready to install 	<ul style="list-style-type: none"> 1 Style number 2 Plastic color number for power 3 Options, if selected (see below) ▶ See <i>Surface Materials</i>, page 298.

Options	U.S. Price	Required to Specify
Power/USB Schematic <ul style="list-style-type: none"> • 1 Power • 2 USB 	No cost +\$75	Specify with 1 power. Specify with 2 USB.
Related Products <ul style="list-style-type: none"> • Box Top Tables • Box Top Tables with Bag Drop 		<ul style="list-style-type: none"> ▶ Page 284 ▶ Page 286

Specification Information	
Style Number	U.S. Base Price
TSBLNPRND	\$100

Module

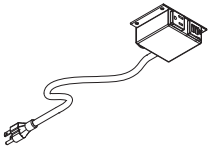

Tip: Box Top Tables and Box Top Tables with Bag Drop have pre-drilled pilot holes to accommodate power.

Standard Includes		Required to Specify
<ul style="list-style-type: none"> ▶ Need help? Product details, page 272 	<ul style="list-style-type: none"> • Two simplex receptacles: 6000 Black • Bracket: 7360 Merle • 72" long 15-amp power cord with wall plug • Cable management twist tie • Shipped ready to install 	<ul style="list-style-type: none"> 1 Style number 2 Options, if selected (see below)

Options	U.S. Price	Required to Specify
Power/USB Schematic <ul style="list-style-type: none"> • 1 Power • 2 USB 	No cost +\$75	Specify with 1 power. Specify with 2 USB.
Related Products <ul style="list-style-type: none"> • Box Top Tables • Box Top Tables with Bag Drop 		<ul style="list-style-type: none"> ▶ Page 284 ▶ Page 286

Specification Information	
Style Number	U.S. Base Price
TSBLNPMOD	\$110



For Canadian Pricing
Multiply U.S. Price by the Canadian price factor.
▶ See page 1 for details.

Surface Materials

► For Surface Materials matrices for all product lines, see page 459.

Laminate

Steelcase Surfaces

Low-Pressure Laminate

Fiber Laminate

- 2L50 Vanadium Fiber
- 2L52 Tungsten Fiber

Metallic Laminate

- 2L03 Brushed Silver **E**

Solid Laminate

- 247L Black
- 2L30 Arctic White
- 2L83 Seagull
- 2L85 Dune
- 2LMG Merle

Woodgrain Laminate

- 25L1 Winter on Maple
- 25L5 Virginia Walnut
- 25L6 Blackwood
- 25L8 Clear Walnut
- 25L9 Warm Oak **E**
- 262L Marbled Maple
- 264L Chocolate Walnut
- 267L Marbled Cherry
- 26L1 Natural Cherry
- 2L09 Clear Maple
- 2LAN Ash Noce
- 2LAT Acacia
- 2LAW Ash Wenge
- 2LBN Bisque Noce
- 2LBW Bisque Wenge
- 2LCN Clay Noce
- 2LCW Clay Wenge
- 2LSN Storm Noce
- 2LSW Storm Wenge

Steelcase Surfaces

High-Pressure Laminate

Fiber Laminate

- 2850 Vanadium Fiber
- 2851 Rhyme Fiber **E**
- 2852 Tungsten Fiber
- 2854 Vellum Fiber
- 2859 Novell Fiber
- 2860 Granite Fiber
- 2861 Coconut Fiber
- 2862 Stucco Fiber

Metallic Laminate

- 2503 Brushed Silver **E**

Tip: Established finishes are available for delivery in 15 business days.

E = Established

Micro Laminate

- 2920 Marl Micro
- 2921 Gypsum Micro
- 2922 Clay Micro
- 2923 Shadow Micro **E**

Patina Laminate

- 2870 Blonde Bronze Patina
- 2871 Blackened Bronze Patina
- 2873 Instant Iron Patina

Solid Laminate

- 2722 Cream **E**
- 2730 Arctic White
- 2746 Black
- 2759 Warm White **E**
- 2811 Mist **E**
- 2883 Seagull
- 2884 Milk
- 2885 Dune
- 2HMG Merle

Speckle Laminate

- 2820 Coffee Speckle **E**
- 2822 Woodrose Speckle **E**
- 2823 Driftwood Speckle
- 2824 Smoke Speckle
- 2825 Vanadium Speckle

Woodgrain Laminate

- 2406 Clear Cherry
- 2409 Clear Maple
- 2410 Graphite Walnut
- 2412 Natural Cherry
- 2422 Medium Cherry
- 2511 Winter on Maple
- 2535 Virginia Walnut
- 2536 Blackwood
- 2538 Clear Walnut
- 2539 Warm Oak **E**
- 2592 Blonde on Maple
- 2612 Marble Maple
- 2614 Chocolate Walnut
- 2615 Marble Cherry
- 2714 Natural Walnut on Walnut
- 2772 Medium Mahogany on Walnut **E**

2HAK Clear Oak

2HAN Ash Noce

2HAT Acacia

2HAW Ash Wenge

2HBN Bisque Noce

2HBW Bisque Wenge

2HCN Clay Noce

2HCW Clear Wenge

2HSN Storm Noce

2HSW Storm Wenge

Select Surfaces

High-Pressure Laminate

Textured Woodgrain Laminate

- 2TH2 Fawn Cypress
- 2TH3 Weathered Char
- 2TH4 Saddle Oak
- 2TH5 Veranda Teak
- 2TH6 Persian Cherry
- 2TH7 Walnut Heights

Custom Surfaces

Open Line Laminate (OLL)

This service allows you to order non-standard laminate at an additional processing fee of \$71 U.S. per unit, plus the cost of the laminate.

When processing orders for Open Line laminate on turnstone products, specify 2900 in the laminate finish field and enter the OLL manufacturer information. Enter the required edge finish as you would a standard laminate.

Edge color for the Open Line laminate on turnstone products must be determined by the dealer and customer before orders can be entered. Specify appropriate 2K finish number. *Tip: Standard laminates being used in the Open Line laminate program to obtain a different edge detail will be charged the Open Line laminate upcharge; however, no additional charges for the laminate will be applied.*

Laminate Approval and Material Requirements

To confirm whether a particular laminate has already been tested for use on a specific Steelcase product or to determine material square foot requirements:

- Visit www.steelcase.com

For additional information, refer to the *Steelcase Surface Materials Reference Manual*.

Upholstery

Applies to:
• Bench Seating

Steelcase Surfaces

Not every upholstery is available on every chair. Please refer to the upholstery matrix on page 485 before specifying.

Price Group 1

- Buzz2
- Jacks **E**
- New Black: Bruce
- New Black: Henry
- Link
- Playground **E**

Price Group 2

- Chainmail
- Cogent: Connect
- Cogent: Geode Vertical **E**
- Cogent: Trails
- New Black: Harley
- New Black: Jack
- New Black: James
- Nitelights
- Seating Vinyl **E**
- Spyder **E**
- Stand In

Price Group 3

- Billiard Multi-Use by Designtex
- Gaja – Cradle to Cradle Certified™ Silver
- Imperma
- Redeem
- Retrieve
- Texel

Price Group 5

- Bo Peep
- Remix
- Silk

Price Group 6

- Brisa

Price Group 7

- Steelcut Trio

Leather Price Group

Steelcase Leather

- L107 Black
- L207 Mahogany
- L220 Soapstone
- L221 Rocky

Elmosoft Leather Price Group

Elmosoft Leather

- L110 Maritime Blue
- L111 Midnight Blue
- L112 Ebony
- L113 Gunmetal
- L114 Mica
- L115 Dove Grey
- L116 Plum Pleasure
- L122 Truffle
- L128 Red Birch
- L132 Violet
- L133 Espresso
- L134 Ruby
- L135 Scarlet
- L138 Bourbon
- L139 Cinder
- L140 Garnet
- L143 Pecan
- L144 Chamois
- L146 Russet
- L147 Saddle
- L151 White
- L709 Sugar
- L711 Parchment
- L712 Buff
- L716 Khaki
- L717 Cameo
- L721 Rock
- L722 Desert
- L723 Storm
- L725 Teal
- L727 Egyptian Blue
- L728 Bright Blue
- L730 Hunter
- L736 Lemon
- L737 Sunshine
- L738 Drama
- L740 Dazzle
- L743 Forest Green
- L744 Turtle
- L745 Grass
- L746 Envy
- L747 Cigar
- L748 Light Chocolate
- L749 Beaver
- L750 Bluffstone
- L751 Sienna
- L752 Oxblood
- L753 Dough
- L754 Acorn
- L755 Peanut Butter
- L756 Quinoa
- L757 Dark Sand
- L758 Mustard
- L759 Amber Orange
- L760 Bengal
- L761 Periwinkle
- L762 Canvas
- L763 Macadamia
- L764 True Blue
- L765 Storm Blue
- L766 Powder Blue
- L767 Blush
- L768 Tropical
- L769 Mauve
- L770 Cadet
- L771 Powder Mint
- L772 Timberwolf
- L773 Chalice
- L774 Oil
- L775 Coyote

Select Surfaces

For information on products within Select Surfaces, including accent paints and fabrics from Designtex, Gabriel, Kvadrat, and Pollack, please refer to the *Surface Materials Reference Manual* or visit www.steelcase.com/surface-materials under the Select Surface section.

Custom Surfaces

Price Group COM (Customer's Own Material)

Fabric Approval and Yardage

To confirm whether a particular COM material has already been tested for use on a specific Steelcase product or to determine actual yardage requirements:

- Visit www.steelcase.com

For additional information regarding Customer's Own Material, call 1.888.STEELCASE.

Applies to:

- Bench Seating

Steelcase Graded-In Program: Upholstery

Steelcase Graded-In Program Partners:

- Architex
- Arc-Com
- CF Stinson
- Designtex
- Mayer
- Momentum
- Ultrafabrics

A collection of textiles are available as part of a Graded-In Program. The collection from the leading suppliers in the market consists of high-performance textiles. Note that not all fabrics can be applied to all seating products. Refer to the Steelcase COM database for the most current application information.

Tip: Established finishes are available for delivery in 15 business days.

Ⓜ = Established

To order these fabrics, enter the finish code which corresponds with the fabric price group.

Price Group	Finish Code
2	59DB
3	59DC
4	59DD
5	59DE
6	59DF
7	59DG
8	59DH
9	59DJ
10	59DK

Then enter the fabric information in the Special Fabric Information pop up window.

Fabric application direction must be specified: For additional information, refer to the *Surface Materials Reference Manual*.

For a comprehensive list of patterns and price grades in Steelcase Health offering, visit steelcasehealth.com/resources/grade-in

Thread

Steelcase Surfaces

Applies to:

- Bench Seating
- UB01 Charcoal
- UB02 Ash
- UB03 Powder Blue
- UB04 Evergreen
- UB05 Bright Red

Plastic

Steelcase Surfaces

- 6000 Black
- 6001 Coffee
- 6009 Arctic White
- 6034 Natural Cherry
- 6036 Medium Cherry
- 6037 Winter on Maple
- 6038 Blonde on Maple
- 6041 Natural Walnut
- 6045 Medium Mahogany on Walnut Ⓜ
- 6052 Milk
- 6053 Seagull
- 6213 Acacia
- 6219 Clear Oak
- 6231 Graphite Walnut
- 6234 Clear Cherry
- 6237 Clear Maple
- 6242 Virginia Walnut
- 6243 Blackwood
- 6245 Clear Walnut
- 6246 Warm Oak Ⓜ
- 6249 Platinum Solid
- 6271 Plywood
- 6527 Merle
- 6615 Grey V5
- 6619 Ice Ⓜ
- 6631 Cream
- 6635 Dawn Ⓜ
- 6636 Mist
- 6654 Sand
- 6655 Warm White
- 6676 Marbled White
- 6677 Chocolate Walnut
- 6678 Marbled Cherry
- 6689 Brushed Silver Ⓜ
- 6694 Slate
- 6695 Midnight
- 6697 Fog
- 6698 Fieldstone
- 6703 Ash Wenge
- 6704 Storm Wenge
- 6705 Bisque Wenge
- 6706 Clay Wenge
- 6707 Ash Noce
- 6708 Bisque Noce
- 6709 Clay Noce
- 6710 Storm Noce

Applies to:

- Round Power

- 5U23 Blue Jay
- 6249 Platinum Solid
- 6337 Element
- 6338 Chili
- 6527 Merle

Tip: Module power is available in black only.

Select Surfaces

- 6T02 Fawn Cypress
- 6T03 Weathered Char
- 6T04 Saddle Oak
- 6T05 Veranda Teak
- 6T06 Persian Cherry
- 6T07 Walnut Heights

Glass

Steelcase Surfaces

Applies to:

- Occasional Tables
- Three Leg Tables

- 6500 Clear
- 6530 Frosted
- ACB Absolute Clear with Black
- ACC Absolute Clear with Crystal Spring
- ACG Absolute Clear with Goldenrod
- ACM Absolute Clear with Midnight
- ACP Absolute Clear with Poppy
- ACS Absolute Clear with Sage

Solid Surfaces

Applies to:

- Occasional Tables
- Three Leg Tables

Steelcase Health Graded-In Program: Solid Surface

A collection of solid surfaces are available as part of a Graded-In Program. The collection is from the Corian solid surface offering. Samples can be ordered through corian.com

To order these solid surfaces, enter the finish code which corresponds with the solid surface price group.

Price Group	Finish Code
A	29DA
B	29DB
C	29DC
D	29DD

Then enter the solid surface information in the Special Solid Surface Information pop up window. If prompted, enter the finish code CORIAN0001 based on the solid surface supplier.

Solid Surface Offering

Price Group A

- Cameo White
- Vanilla

Price Group B

- Abalone
- Aurora
- Canyon
- Maui
- Modern White
- Mojave
- Moss
- Platinum
- Sahara
- Sand
- Sandstone
- Savannah
- Silt

Price Group C

- Anthracite
- Arctic Ice
- Blue Pebble
- Bronzite
- Cobalt
- Cocoa Brown
- Concrete
- Cottage Lane
- Deep Night Sky
- Deep Nocturne
- Designer White
- Doeskin
- Dove
- Fawn
- Flint
- Fossil
- Glacier Ice
- Granola
- Matterhorn
- Oat
- Pine
- Raffia
- Rice Paper
- Seafoam
- Serene Sage
- Silver Birch
- Silverite
- Suede
- Venaro White
- Whisper
- White Jasmine
- Willow

Surface Materials, continued

Price Group D

- Aqualite
- Arrowroot
- Burled Beach
- Clam Shell
- Earth
- Ecru
- Elderberry
- Graylite
- Juniper
- Lava Rock
- Milky Way
- Natural Gray
- Rain Cloud
- Rosemary
- Sagebrush
- Sand Storm
- Sandalwood
- Sonora
- Sorrel
- Stardust
- Thyme
- Tumbleweed
- Witch Hazel

Standard Steelcase Corian finishes:

Price Group A

- 2801 Glacier White
- 2975 Bisque

Price Group B

- 2973 Linen

Price Group C

- 2972 Antarctica
- 2974 Canvas

Wood

Steelcase Surfaces

Veneer

Veneers are matched for proper balance and consistency. Veneers are available flat cut or quarter cut, except for Oak, which is rift cut. Refer to the *Surface Materials Reference Manual* for descriptions of each cut.

Open-pore finish is a medium gloss finish that leaves the wood grain texture visible to the eye and distinguishable to the touch.

Flat-cut open-pore finish choices

- 3062 FC/OP Graphite Walnut
- 3402 FC/OP Clear Cherry (Aged)
- 3412 FC/OP Natural Cherry **E**
- 3422 FC/OP Medium Cherry
- 3442 FC/OP MS-Medium Cherry
- 3522 FC/OP Clear Maple*
- 3572 FC/OP Amber on Maple **E**
- 3582 FC/OP Winter on Maple
- 3592 FC/OP Blonde on Maple
- 3702 FC/OP Clear Walnut
- 3712 FC/OP Natural Walnut
- 3722 FC/OP Dark Mahogany on Walnut
- 3752 FC/OP Medium Walnut
- 3762 FC/OP Dark Walnut
- 3772 FC/OP Medium Mahogany on Walnut

Quarter-cut open-pore finish choices

- 3042 QC/OP Ash*
- 3222 QC/OP Clear Maple*
- 3272 QC/OP Amber on Maple **E**
- 3292 QC/OP Blonde on Maple
- 3302 QC/OP Clear Walnut
- 3312 QC/OP Natural Walnut
- 3322 QC/OP Dark Mahogany on Walnut
- 3352 QC/OP Medium Walnut
- 3362 QC/OP Dark Walnut
- 3372 QC/OP Medium Mahogany on Walnut
- 3382 QC/OP Graphite Walnut

Rift-cut open-pore finish choices

- 3602 RC/OP Desert Oak
- 3611 RC/OP Natural Oak*
- 3612 RC/OP Warm Oak **E**
- 3692 RC/OP Espresso Oak

* Available on Three Leg Tables and Bench side tables only.

Full-fill finish is a medium-gloss finish that completely fills the grain texture, yet allows the grain pattern to be seen. The wood has a lustrous, satiny look, and it is smooth to the touch. This finish is available on the wood worksurface or top only.

Tip: For ease of specification, full-fill finish codes can be selected on other veneer components being used in settings with full-fill veneer worksurfaces. The other components will not have the final fill coat applied, but the finish color will be consistent with the full-fill worksurfaces.

Flat-cut full-fill finish choices

- 3064 FC/FF Graphite Walnut
- 3404 FC/FF Clear Cherry (Aged)
- 3414 FC/FF Natural Cherry **E**
- 3424 FC/FF Medium Cherry
- 3524 FC/FF Clear Maple*
- 3544 FC/FF Blonde on Maple
- 3574 FC/FF Amber on Maple **E**
- 3704 FC/FF Clear Walnut
- 3714 FC/FF Natural Walnut
- 3724 FC/FF Dark Mahogany on Walnut
- 3754 FC/FF Medium Walnut
- 3764 FC/FF Dark Walnut
- 3774 FC/FF Medium Mahogany on Walnut

Quarter-cut full-fill finish choices

- 3224 QC/FF Clear Maple*
- 3274 QC/FF Amber on Maple **E**
- 3294 QC/FF Blonde on Maple
- 3304 QC/FF Clear Walnut
- 3314 QC/FF Natural Walnut
- 3324 QC/FF Dark Mahogany on Walnut
- 3354 QC/FF Medium Walnut
- 3364 QC/FF Dark Walnut
- 3374 QC/FF Medium Mahogany on Walnut
- 3384 QC/FF Graphite Walnut

Rift-cut full-fill finish choices

- 3604 RC/FF Desert Oak
- 3614 RC/FF Warm Oak **E**
- 3694 RC/FF Espresso Oak

*To ensure an understanding of the color ranges and characteristic variations of natural veneer, a sign-off sheet is required prior to orders being accepted for this clear-coat finish. The sign-off sheet is available through Steelcase advertising stock. Please use form number 09-0000756 for 3042, form number 05-0001370 for 3222 and 3224.

Premium Veneers

A selection of Premium veneers in this collection are available on most Steelcase brand products. The collection will be available as close to standard leadtimes as possible. However, because adequate supplies of veneer and solids must be secured, all orders will be scheduled individually. Leadtimes will vary based on Premium veneer and Premium solids availability at the time the order is placed. The collection is Graded-In as Wood Group 2 and Wood Group 3, and supported like standard veneers to make ordering easy. Please see the Steelcase surface materials section on *village.steelcase.com* for sample information and product line availability. All premium veneers are in clear-coat.

Tip: Established finishes are available for delivery in 15 business days.

E = Established

Quarter-cut open-pore finish choices

Wood Group 2

- 3032 QC/OP Dark Thin Line Bamboo
- 3052 QC/OP Ribbon Sapele

Wood Group 3

- 3832 QC/OP Figured Anegre
- 3842 QC/OP Figured Makore

Tip: Full-fill finish is not available on premium veneers as a standard.

**To ensure an understanding of the color ranges and characteristic variations of natural veneer, a sign-off sheet is required prior to orders being accepted for this clear-coat finish. The sign-off sheet is available through Steelcase advertising stock. Please use form number 09-0000755 for 3032, form number 09-0000757 for 3052, form number 09-0000758 for 3832, and form number 09-0000759 for 3842.*

Select Surfaces

For information on products within Select Surfaces, including accent paints and fabrics from Designtex, Gabriel, Kvadrat, and Pollack, please refer to the *Surface Materials Reference Manual* or visit steelcase.com/surface-materials under the Select Surfaces section.

Composite Veneer

Composite veneers are an engineered wood intended to create specific grain patterns and characteristics. They are pre-stained and finished with Steelcase's Clarity water-borne UV topcoat, which protects the environment while providing durability and clarity. Only open-pore finishes are available on composite wood. Composite veneer and matching edge bands are available on most Steelcase brand products. Composites, for us as a solid nosing substitute, are not available. Steelcase does not recommend mixing composite veneers with natural solid nosings because composite and natural wood grain and color matching are rarely compatible. Composite veneers are Graded-In as Wood Group 1 pricing.

Flat-cut open-pore finish choices

- 3JDX FC/OP Oak Composite
- 3JFX FC/OP Maple Composite
- 3JHX FC/OP Cherry Composite
- 3JJX FC/OP Walnut Composite

Quarter-cut open-pore finish choices

- 3F8X QC/OP European Walnut Composite
- 3GAX QC/OP Gold Teak Composite
- 3GFX QC/OP Rosewood Composite
- 3GGX QC/OP Zebano Composite
- 3HGX QC/OP Oak Composite
- 3H VX QC/OP Walnut Composite
- 3JEX QC/OP Maple Composite
- 3JGX QC/OP Cherry Composite
- 3ZNX QC/OP Night Cerused Oak Composite

Tip: Established finishes are available for delivery in 15 business days.

E = Established

Planked Veneer

Planked veneer is available in the Select Surfaces offering. Planked veneer may have extended leadtimes. Place your order as you normally would for any other finish, calling out the appropriate finish code.

The following finishes are available through the planked veneer offering:

Wood Group 1

- 3P41 OP Planked Cherry
- 3P51 OP Planked Maple
- 3P61 OP Planked Oak
- 3P71 OP Planked Walnut

Tip: Known for its uniqueness, planked veneer has intentional and natural variations that include, but are not limited to: character marks, grain pattern, color, and natural color aging.

Custom Surfaces

Customiz stain is a service that allows you to create your own stain colors and finishes on standard veneer. Customiz stain color is available on all product lines that offer wood veneer.

A \$500 stain-matching fee applies on CUSTOMIZ requests (Exception: The \$500 fee does not apply on matches to Coalesse standard finishes or for a low-gloss finish request on a standard color). The \$500 fee covers the cost of formulating the Customiz color finish and applies regardless of whether or not an order for product is placed.

In addition, an approval form must be signed to indicate customer acceptance of Customiz match. A \$1,500 initiation fee will be charged prior to first order entry. This initiation fee activates the finish for unlimited use on any Steelcase product for an 18 month time period. After the 18 month time period has lapsed, the Customiz finish may be reactivated for another 18 months for a \$1,000 fee at any point within five years after the \$1,500 initiation fee was paid. If the finish is not reactivated within five years after the \$1,500 initiation fee was paid, the finish will be culled and the customer will need to pay the \$1,500 initiation fee again. All style number related Customiz charges products are no cost as of April 2014. The matching and initiation fees are not discountable.

Customiz stain takes 10 days to formulate. Consult the *Surface Materials Reference Manual* for more information. Custom veneers are also available and must be quoted by Steelcase specials group. Customiz stain on custom veneers takes 2 to 4 weeks to formulate.

Requirements and information on ordering a Customiz stain color are found in the *Surface Materials Reference Manual*.

Tip: Due to natural variations in wood, finished products may vary in color, texture, and grain.

Paint

Steelcase Surfaces

Applies to:

- Table Bases
- Metal Accent Panel

Price Group 1

Smooth Paint

- 4242 Milk

Textured Paint

- 7207 Black
- 7225 Sand
- 7236 Fog
- 7237 Slate
- 7238 Fieldstone
- 7239 Midnight
- 7241 Arctic White
- 7243 Seagull
- 7250 Sterling Dark Solid
- 7278 Dark Bronze
- 7360 Merle

Price Group 2

Standard Paint

- 0835 Black **E**
- 4140 Arctic White Gloss
- 4144 Black Gloss

Metallic Paint

- 4728 Nickel Metallic
- 4743 Mineral Metallic
- 4744 Pearl Metallic
- 4750 Champagne Metallic
- 4752 Steel Metallic
- 4788 Gold Dust Metallic
- 4798 Sterling Metallic
- 4799 Platinum Metallic
- 4803 Near Black Metallic

Textured Metallic

- 7245 Carbon Metallic
- 7246 Midnight Metallic

Steelcase Surfaces

Price Group 3

Accent Paint

Accent paints allow you to choose from a pre-matched color palette of trend driven colors. Refer to the *Surface Materials Reference Manual* for more information.

Surface Materials, continued

Custom Surfaces

Perfect Match

PerfectMatch is a service that allows you to create your own paint color. Refer to the *Surface Materials Reference Manual* for more information about this program.

Price Group 3

4990 PerfectMatch Paint

Applies to:

- Table Bases

Select Surfaces

Lux Coatings

- 4B20 Obsidian
- 4B22 Matte Brass
- 4B23 Burnished Bronze
- 4B24 Night Bronze
- 4B25 Matte Copper